

## 3mm Round LED (T-1)

### Features

- Popular T-1 diameter package
- Choice of various viewing angles
- Reliable and robust



**T-1**

### Descriptions

- The series is specially designed for applications requiring higher brightness.
- The LED lamps are available with different colors, intensities.

### Applications

- TV set
- Monitor
- Telephone
- Computer

### Device Selection Guide

Part No.	Chip		Lens Color
	Material	Emitted Color	
TLN-Y4R3-204	GaAsP/GaP	Yellow	Color Diffused

**Absolute Maximum Ratings (Ta=25°C)**

Parameter	Symbol	Value	Unit
Reverse Voltage	<b>VR</b>	5	V
Continuous Forward Current	<b>IF</b>	25	mA
Peak Forward Current (Duty 1/10@1KHZ)	<b>IFP</b>	160	mA
Power Dissipation	<b>Pd</b>	85	mW
Operating Temperature	<b>Topr</b>	-40 ~ +85	°C
Storage Temperature	<b>Tstg</b>	-40 ~ +100	°C
Soldering Temperature (Note.1)	<b>Tsol</b>	260 ±5	°C

**Note 1:**

Soldering time ≤ 5 seconds

**Electro-Optical Characteristics (Ta=25°C)**

Parameter	Symbol	Min.	Typ.	Max.	Unit	Condition
Luminous Intensity	<b>Iv</b>	4.0	6.3	-----	mcd	IF =10mA
Viewing Angle	<b>2θ1/2</b>	-----	70	-----	deg	IF =20mA
Peak wavelength	<b>λp</b>	-----	585	-----	nm	
Dominant wavelength	<b>λd</b>	-----	590	-----	nm	
Spectrum Radiation Bandwidth	<b>Δλ</b>	-----	35	-----	nm	
Forward Voltage	<b>VF</b>	1.7	2.0	2.4	V	
Reverse Current	<b>IR</b>	-----	-----	10	μA	VR=5V

### Typical Electro-Optical Characteristics Curves ( $T_a=25^\circ\text{C}$ )

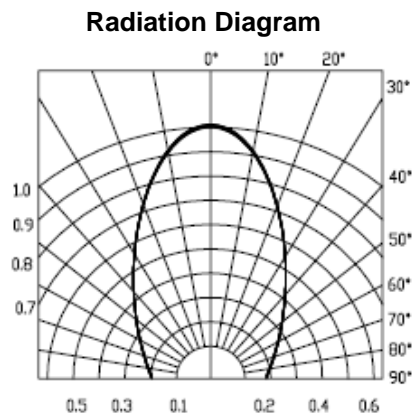
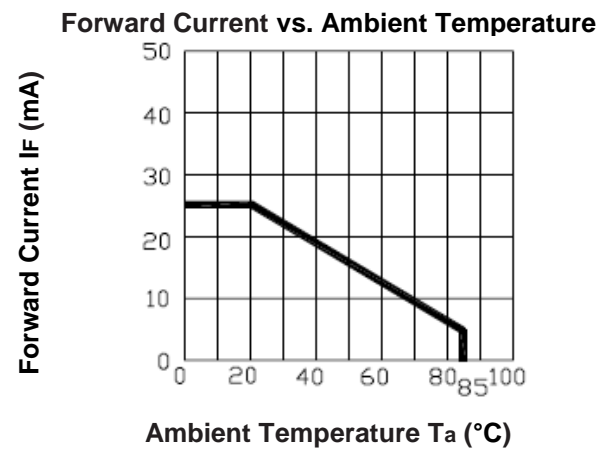
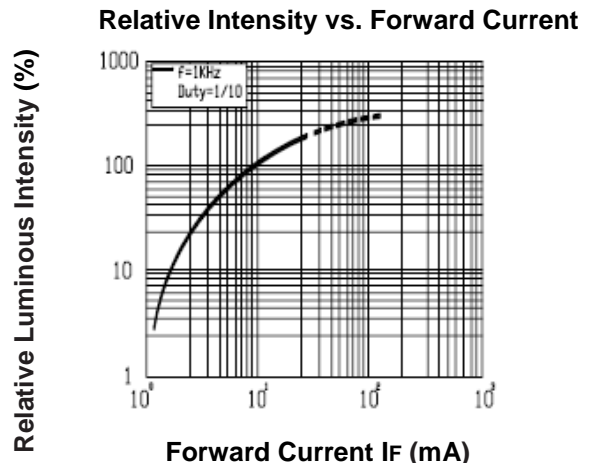
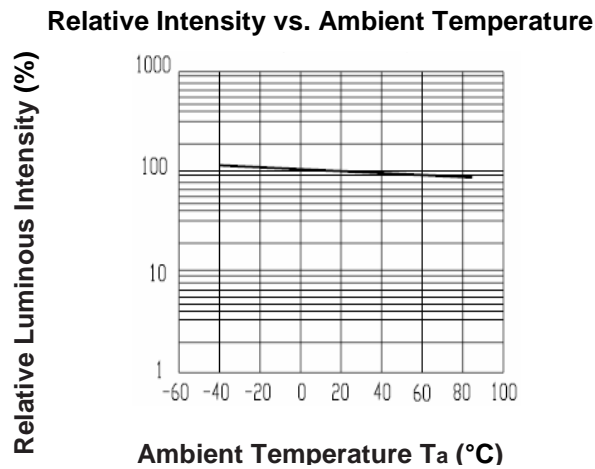
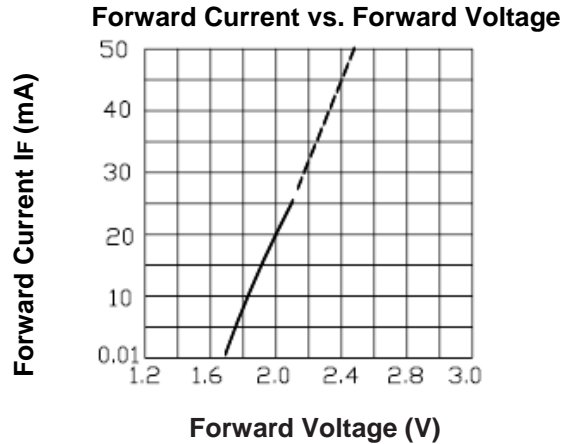
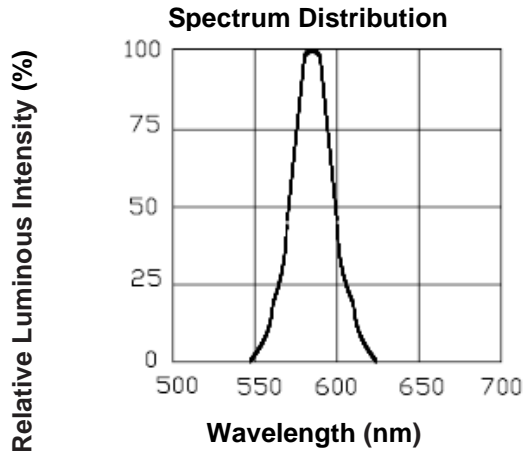

### Package Dimensions (In mm)

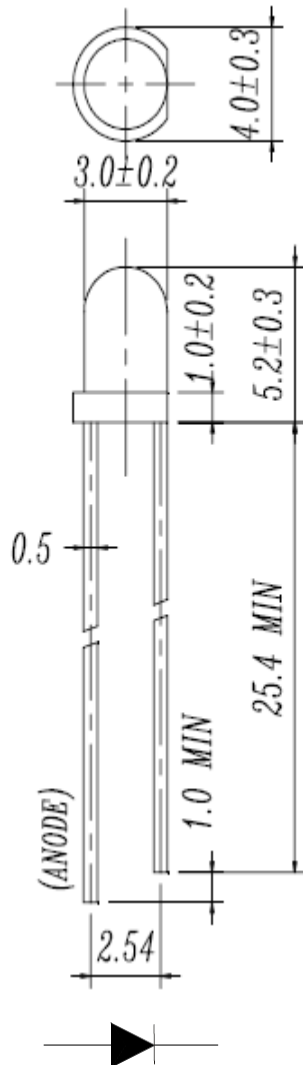

#### Note:

1. All dimensions are in millimeters, and tolerance is 0.25mm without special declared.
2. An epoxy meniscus may extend about 1.5mm down the lead.

### Packing Quantity Specification

1. 1000 Pcs/1 Bag, 5 Bags/1 Box
2. 10 Boxes/1 Carton

### Ordering Information

TL N - Y 4 R 3 - 204 - 92 - B

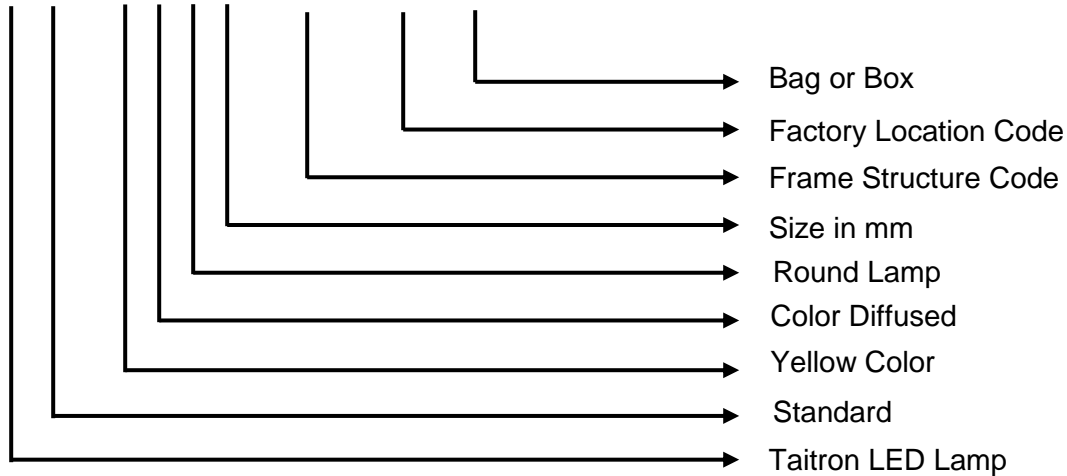

### How to contact us

#### USA HEADQUARTERS

28040 WEST HARRISON PARKWAY, VALENCIA, CA 91355-4162

Tel: (800)-TAITRON (800)-824-8766 (661)-257-6060

Fax: (800)-TAITFAX (800)-824-8329 (661)-257-6415

Email: [taitron@taitroncomponents.com](mailto:taitron@taitroncomponents.com)

Http://[www.taitroncomponents.com](http://www.taitroncomponents.com)

#### TAITRON COMPONENTS INCORPORATED TAIWAN BRANCH

6F., NO.190, SEC. 2, ZHONGXING RD., XINDIAN DIST., NEW TAIPEI CITY 23146, TAIWAN R.O.C.

Tel: 886-2-2913-6238

Fax: 886-2-2913-6239

#### TAITRON COMPONENT TECHNOLOG SHANGHAI CORPORATION

SUITE 1503, METROBANK PLAZA, 1160 WEST YAN'AN ROAD, SHANGHAI, 200052, CHINA

Tel: +86-21-5424-9942

Fax: +86-21-2302-5027