

3mm Dome Power LED

Features

- High flux output
- Low profile
- Low thermal resistance
- Design for high current operation
- Packaged in Tubes for use with automatic insertion equipment



Piranha

Descriptions

- This revolutionary package design allows the light designer to reduce the number of LEDs required and provide a more uniform and unique illuminated appearance than with other LED solutions. This is possible through the efficient optical package design and high-current capabilities.
- The low profile package can be easily coupled with reflectors or lenses to efficiently distribute light and provide the desired light appearance.

Applications

- Automotive Exterior Lighting
- Electronic Signs and Signals
- Channel Letter
- Special Lighting application

Device Selection Guide

Part No.	Chip		Lens Color
	Material	Emitted Color	
TLN-T1W3-3001	GaN	True Green	Water Clear

Absolute Maximum Ratings ($T_a=25^\circ\text{C}$)

Parameter	Symbol	Value	Unit
Reverse Voltage	V_R	5	V
Continuous Forward Current	I_F	30	mA
Power Dissipation	P_d	120	mW
Soldering Temperature (Note.1)	T_{sol}	260 ± 5	$^\circ\text{C}$
Operating Temperature	T_{opr}	$-20 \sim +85$	$^\circ\text{C}$
Storage Temperature	T_{stg}	$-30 \sim +100$	$^\circ\text{C}$

Note 1: Soldering time \leq 5 seconds

Electro-Optical Characteristics ($T_a=25^\circ\text{C}$)

Parameter	Symbol	Min.	Typ.	Max.	Unit	Condition
Luminous Flux	Φ_v	250	400	-----	mlm	$I_F = 20\text{mA}$
Viewing Angle	$2\theta_{1/2}$	-----	60	-----	deg	
Peak wavelength	λ_p	-----	525	-----	nm	
Dominant wavelength	λ_d	-----	530	-----	nm	
Spectrum Radiation Bandwidth	$\Delta\lambda$	-----	35	-----	nm	
Forward Voltage	V_F	3.0	3.5	4.0	V	$V_R = 5\text{V}$
Reverse Current	I_R	-----	-----	10	μA	
Recommend Operating Current	$I_F(\text{Rec})$	-----	-----	20	mA	
DC Forward Current	$I_F(\text{mA})$	-----	-----	30	mA	

Notes: Tolerance of Luminous Flux: $\pm 15\%$

Tolerance of Forward Voltage: $\pm 0.1\text{V}$

Tolerance of Dominant Wavelength $\pm 1.0\text{nm}$

Typical Electro-Optical Characteristics Curves (Ta=25°C)

Relative Intensity vs. Wavelength

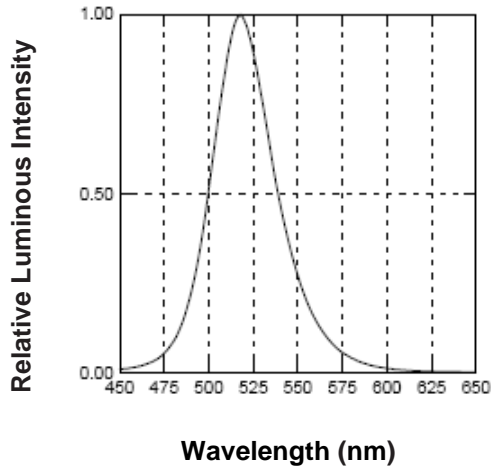

Forward Current vs. Forward Voltage

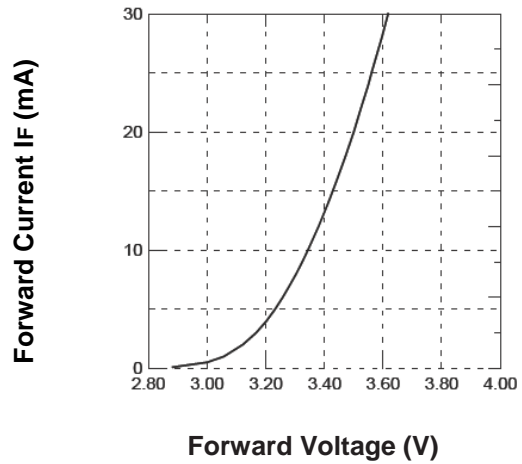

Forward Current vs. Ambient Temp

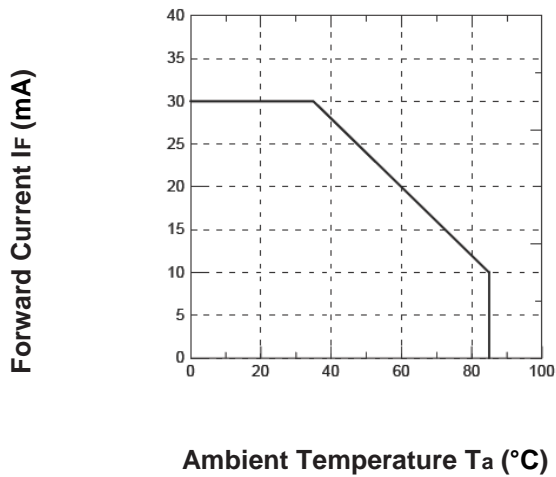

Relative Intensity vs. Displacement Angle

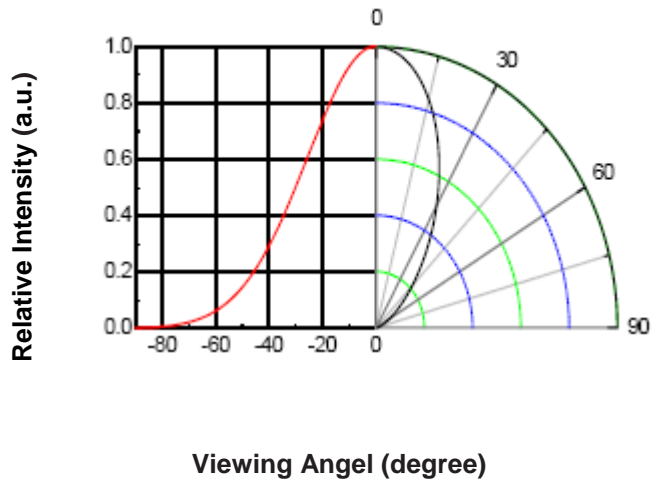

Package Dimensions (In mm)

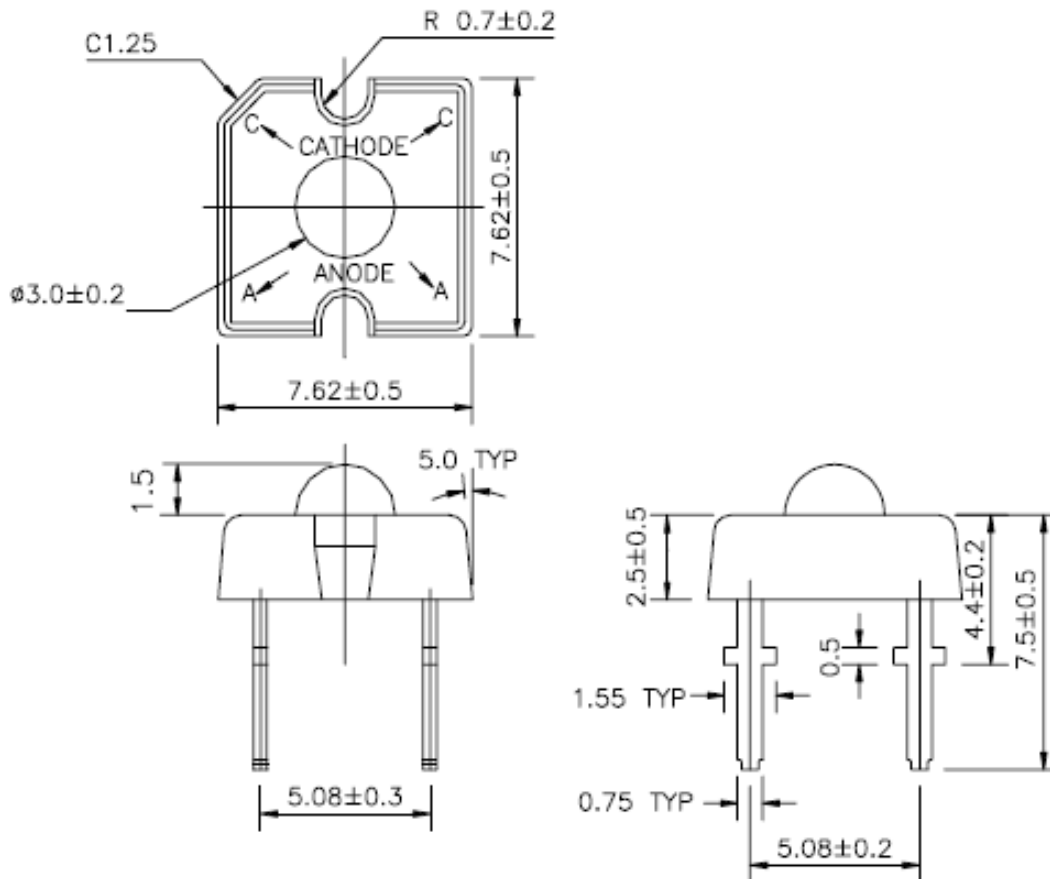

Notes:

1. All dimensions are in millimeters, and tolerance is 0.25mm without special declared.
2. An epoxy meniscus may extend about 1.5mm (0.059") down the lead.

Packing Information

Packing Type	PCS per Tube	PCS Per Inner Box	PCS Per Carton
Tube	60	1,200	14,400

Packing Specification

1. Tube

Cross section image of tube

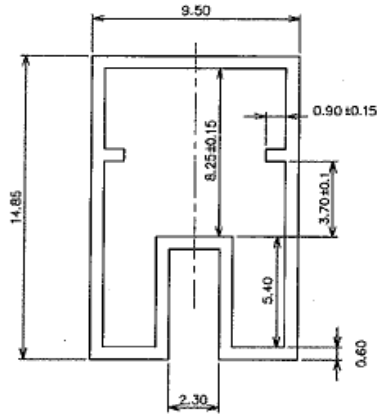

Unit: mm

Whole image of tube

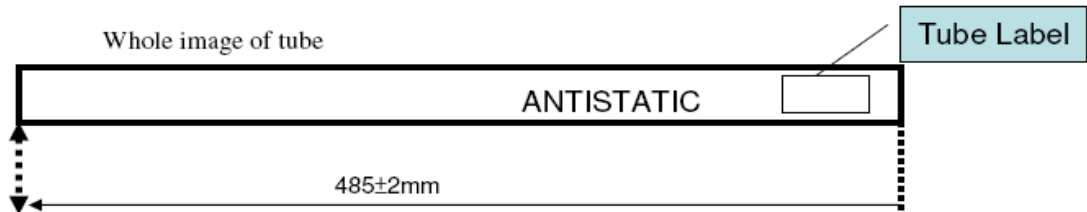

2. Inner Box

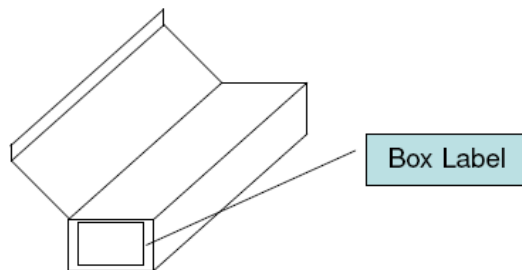

3. Carton (out box)

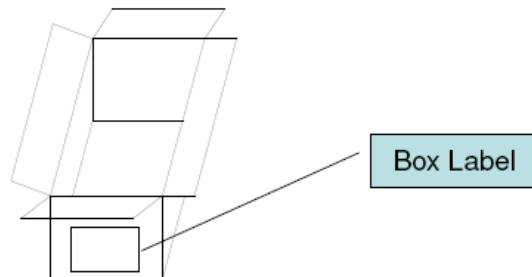

Ordering Information

TL N - T 1 W 3 - 3001 - 92 - C

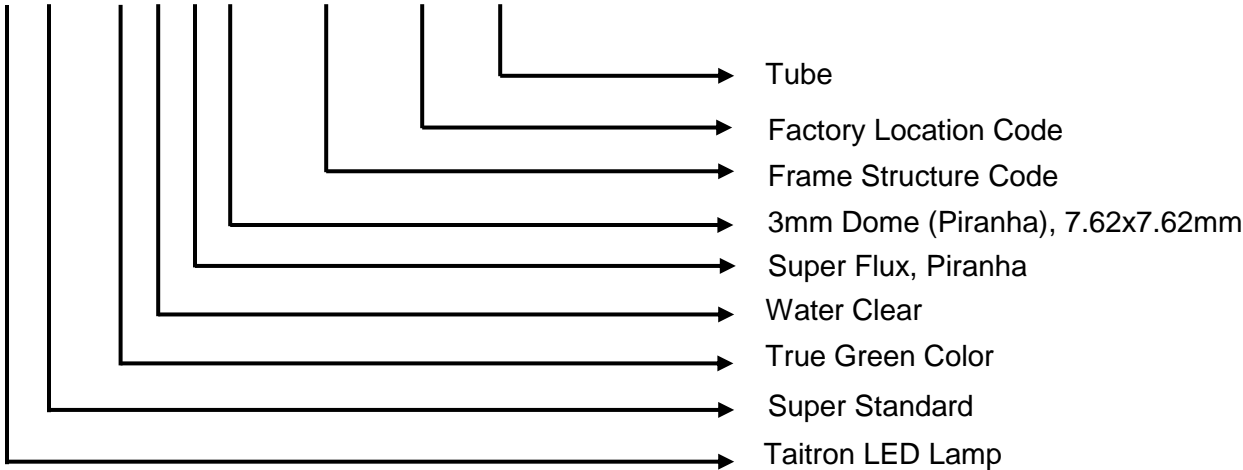

Rank Combinations

Bin Range of Luminous Flux

Bin Code	Min.	Max.	Unit	Condition
T	250	500	mlm	IF=20 mA
U	400	800		
V	630	1250		
W	1000	2000		

Notes: Tolerance of Luminous Flux: ±15%

How to contact us

USA HEADQUARTERS

28040 WEST HARRISON PARKWAY, VALENCIA, CA 91355-4162

Tel: (800)-TAITRON (800)-824-8766 (661)-257-6060

Fax: (800)-TAITFAX (800)-824-8329 (661)-257-6415

Email: taitron@taitroncomponents.com

Http://www.taitroncomponents.com

TAITRON COMPONENTS INCORPORATED TAIWAN BRANCH

6F., NO.190, SEC. 2, ZHONGXING RD., XINDIAN DIST., NEW TAIPEI CITY 23146, TAIWAN R.O.C.

Tel: 886-2-2913-6238

Fax: 886-2-2913-6239

TAITRON COMPONENT TECHNOLOG SHANGHAI CORPORATION

SUITE 1503, METROBANK PLAZA, 1160 WEST YAN'AN ROAD, SHANGHAI, 200052, CHINA

Tel: +86-21-5424-9942

Fax: +86-21-2302-5027