

### 3mm Round LED (T-1) Small Flange with Stand-Off

#### Features

- Popular T-1 diameter package
- High luminous power
- Can be driven at low current
- 2.54mm lead spacing



**T-1**

#### Descriptions

- The series is specially designed for applications requiring higher brightness.
- The LED lamps are available with different colors, intensities, etc.

#### Applications

- TV set
- Monitor
- Telephone
- Computer

#### Device Selection Guide

Part No.	Chip		Lens Color
	Material	Emitted Color	
TLN-G4R3S-2647V	GaP	Green	Color Diffused

# 3mm Round LED Small Flange with Stand-Off

## TLN-G4R3S-2647V

### Absolute Maximum Ratings (Ta=25°C)

Parameter	Symbol	Value	Unit
Reverse Voltage	<b>VR</b>	5	V
Continuous Forward Current	<b>IF</b>	30	mA
Peak Forward Current (Duty 1/10@1KHZ)	<b>IFP</b>	160	mA
Power Dissipation	<b>Pd</b>	100	mW
Operating Temperature	<b>Topr</b>	-40 ~ +85	°C
Storage Temperature	<b>Tstg</b>	-40 ~ +100	°C
Soldering Temperature (Note.1)	<b>Tsol</b>	260 ±5	°C

**Note 1:**

Soldering time ≤ 5 seconds

### Electro-Optical Characteristics (Ta=25°C)

Parameter	Symbol	Min.	Typ.	Max.	Unit	Condition
Luminous Intensity	<b>Iv</b>	10	20	-----	mcd	IF =20mA
Viewing Angle	<b>2θ1/2</b>	-----	60	-----	deg	
Peak wavelength	<b>λp</b>	-----	570	-----	nm	
Dominant wavelength	<b>λd</b>	-----	571	-----	nm	
Spectrum Radiation Bandwidth	<b>Δλ</b>	-----	30	-----	nm	
Forward Voltage	<b>VF</b>	1.7	2.1	2.4	V	
Reverse Current	<b>IR</b>	-----	-----	10	μA	VR=5V

**Notes:** Tolerance of Luminous Intensity: ±10%

Tolerance of Dominant wavelength: ±1.0nm

Tolerance of Forward Voltage: ±0.1V

# 3mm Round LED Small Flange with Stand-Off

## TLN-G4R3S-2647V

### Typical Electro-Optical Characteristics Curves ( $T_a=25^\circ\text{C}$ )

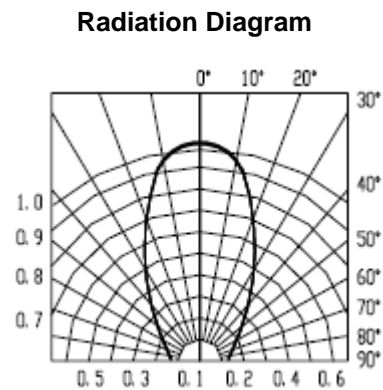
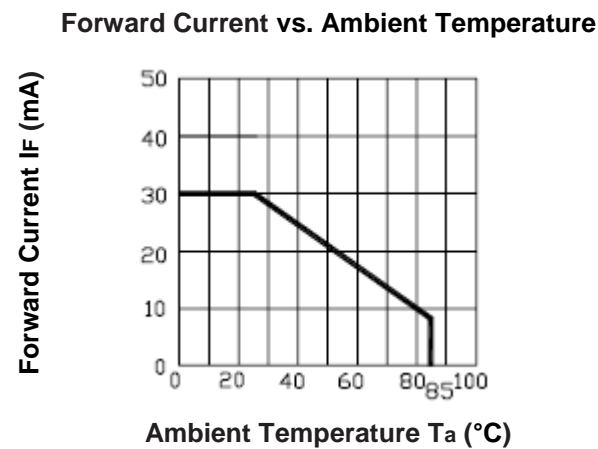
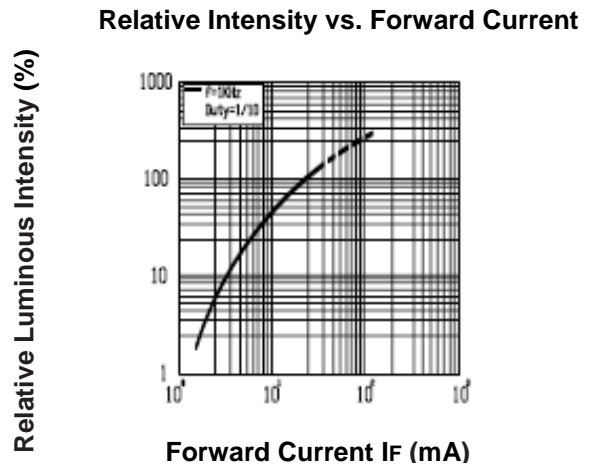
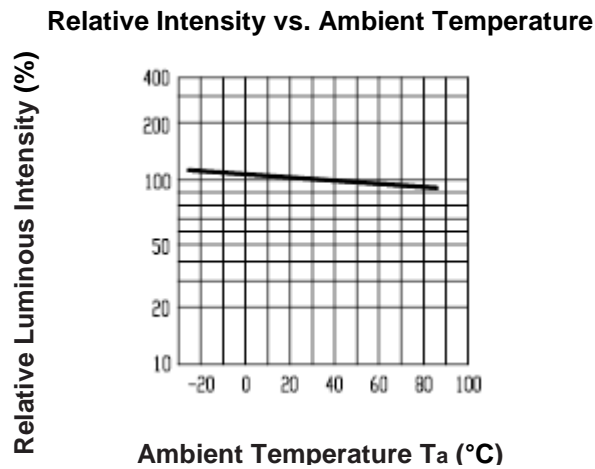
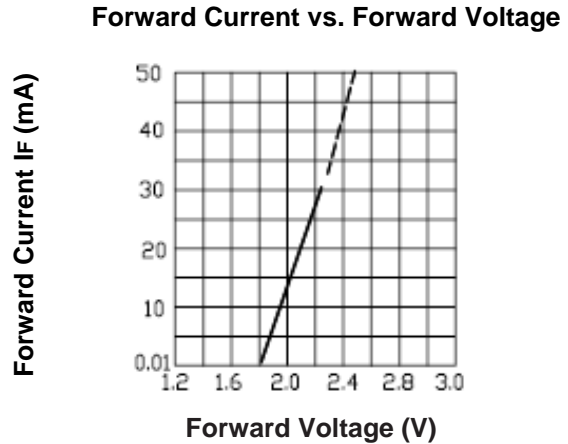
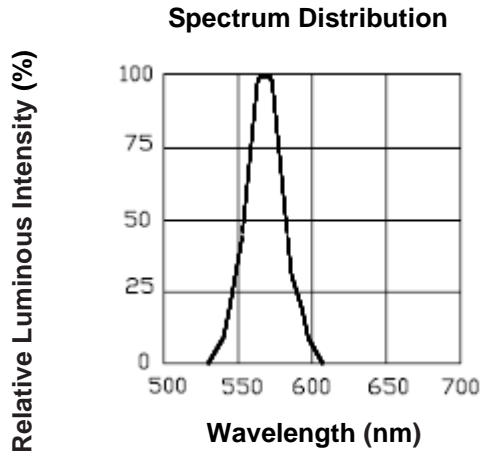

# 3mm Round LED Small Flange with Stand-Off

## TLN-G4R3S-2647V

### Package Dimensions (In mm)

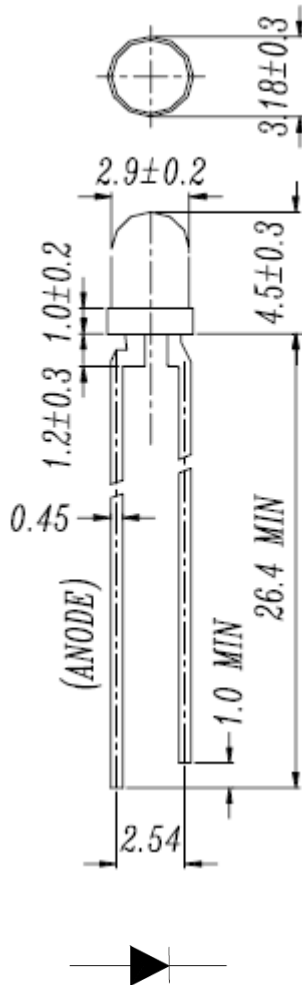

#### Note:

1. All dimensions are in millimeters, and tolerance is 0.25mm without special declared.
2. An epoxy meniscus may extend about 1.5mm down the lead.

### Packing Quantity Specification

Packing Type	PCS per Bag	PCS Per Inner Box	PCS Per Carton
Bulk	1,000	4,000	40,000

# 3mm Round LED Small Flange with Stand-Off

## TLN-G4R3S-2647V

### Ordering Information

TL N - G 4 R 3 S - 2647V - 92 - B

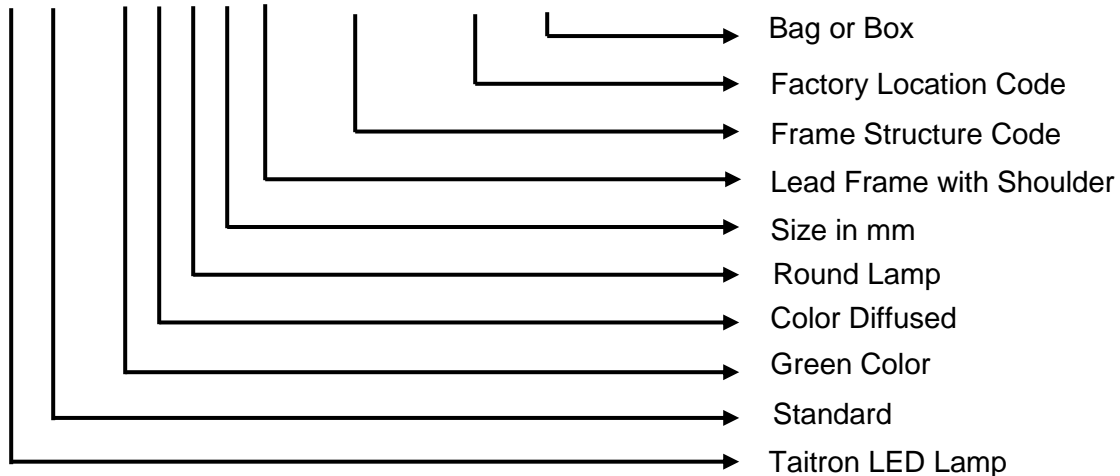

### How to contact us

#### USA HEADQUARTERS

28040 WEST HARRISON PARKWAY, VALENCIA, CA 91355-4162

Tel: (800)-TAITRON (800)-824-8766 (661)-257-6060

Fax: (800)-TAITFAX (800)-824-8329 (661)-257-6415

Email: [taitron@taitroncomponents.com](mailto:taitron@taitroncomponents.com)

Http://[www.taitroncomponents.com](http://www.taitroncomponents.com)

#### TAITRON COMPONENTS INCORPORATED TAIWAN BRANCH

6F., NO.190, SEC. 2, ZHONGXING RD., XINDIAN DIST., NEW TAIPEI CITY 23146, TAIWAN R.O.C.

Tel: 886-2-2913-6238

Fax: 886-2-2913-6239

#### TAITRON COMPONENT TECHNOLOG SHANGHAI CORPORATION

SUITE 1503, METROBANK PLAZA, 1160 WEST YAN'AN ROAD, SHANGHAI, 200052, CHINA

Tel: +86-21-5424-9942

Fax: +86-21-2302-5027