

3mm Round Small Flange without stand-off LED (T-1)

Features

- Popular T-1 diameter package
- High luminous power
- Can be driven at low current



T-1

Descriptions

- The series is specially designed for applications requiring higher brightness.
- The LED lamps are available with different colors, intensities.

Applications

- TV set
- Monitor
- Telephone
- Computer

Device Selection Guide

Part No.	Chip		Lens Color
	Material	Emitted Color	
TLN-G4R3-1254	GaP	Green	Color Diffused

3mm Round Small Flange without stand-off LED

TLN-G4R3-1254

Absolute Maximum Ratings (Ta=25°C)

Parameter	Symbol	Value	Unit
Reverse Voltage	VR	5	V
Continuous Forward Current	IF	30	mA
Power Dissipation	Pd	100	mW
Peak Forward Current (Duty 1/10@1KHZ)	IFP	160	mA
Soldering Temperature (Note.1)	Tsol	260 ±5	°C
Operating Temperature	Topr	-40 ~ +85	°C
Storage Temperature	Tstg	-40 ~ +100	°C

Note 1:

Soldering time ≤ 5 seconds

Electro-Optical Characteristics (Ta=25°C)

Parameter	Symbol	Min.	Typ.	Max.	Unit	Condition
Luminous Intensity	Iv	10.0	16.0	-----	mcd	IF =10mA
Viewing Angle	2θ1/2	-----	40	-----	deg	IF =20mA
Peak wavelength	λp	-----	565	-----	nm	
Dominant wavelength	λd	-----	570	-----	nm	
Spectrum Radiation Bandwidth	Δλ	-----	30	-----	nm	
Forward Voltage	VF	1.7	2.1	2.4	V	
Reverse Current	IR	-----	-----	10	μA	VR=5V

Notes: Tolerance of Luminous Intensity: ±10%

Tolerance of Dominant wavelength: ±1.0nm

Tolerance of Forward Voltage: ±0.1V

Typical Electro-Optical Characteristics Curves (Ta=25°C)

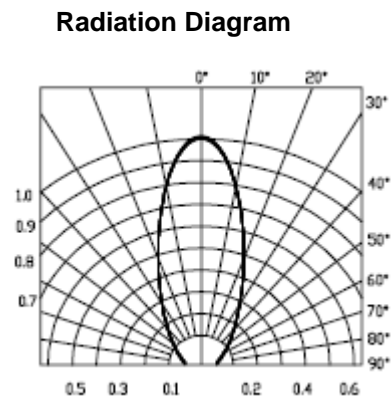
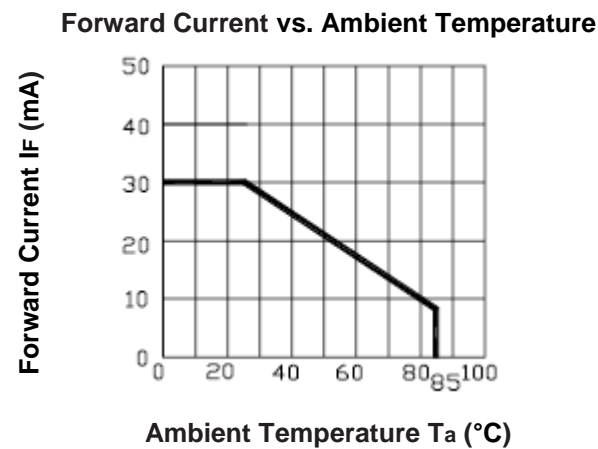
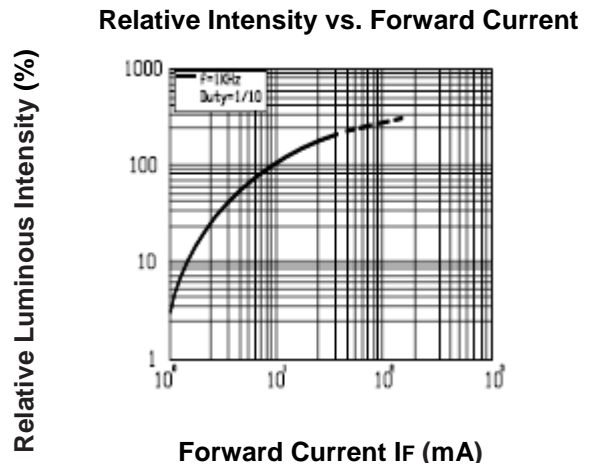
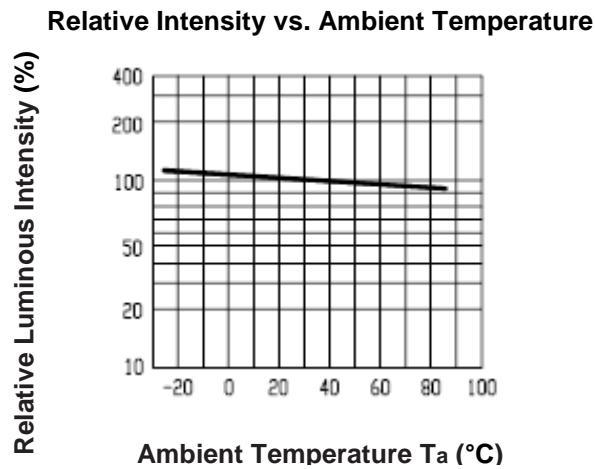
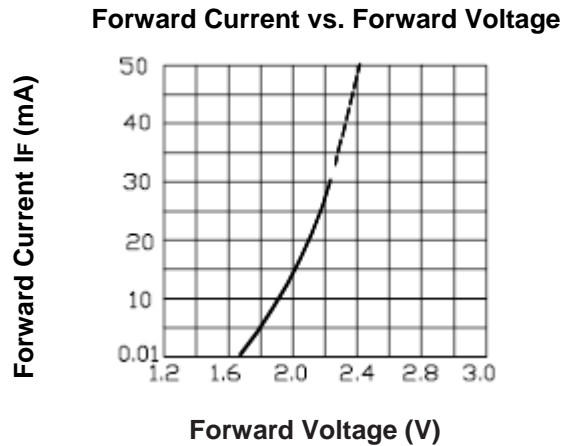
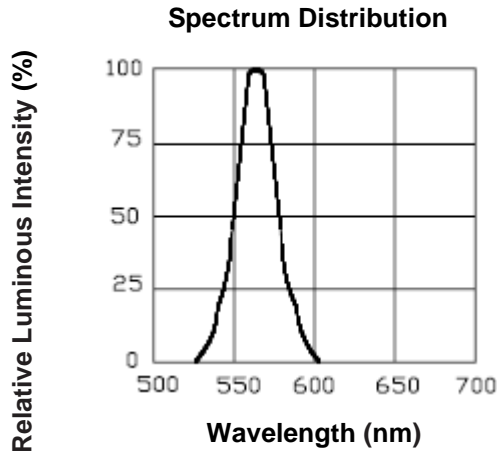

Package Dimensions (In mm)

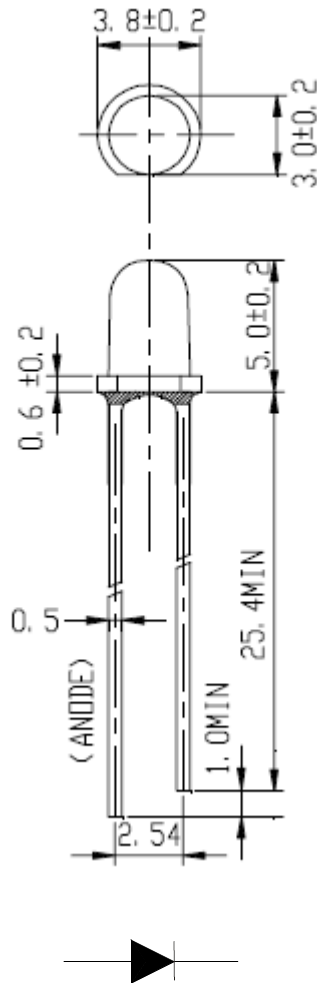

Note:

1. All dimensions are in millimeters, and tolerance is 0.25mm without special declared.
2. An epoxy meniscus may extend about 1.5mm down the lead.

Packing Quantity Specification

1. 1000 Pcs/1 Bag, 4 Bags/1 Box

3mm Round Small Flange without stand-off LED

TLN-G4R3-1254

Ordering Information

TL N - G 4 R 3 - 1254 - 92 - B

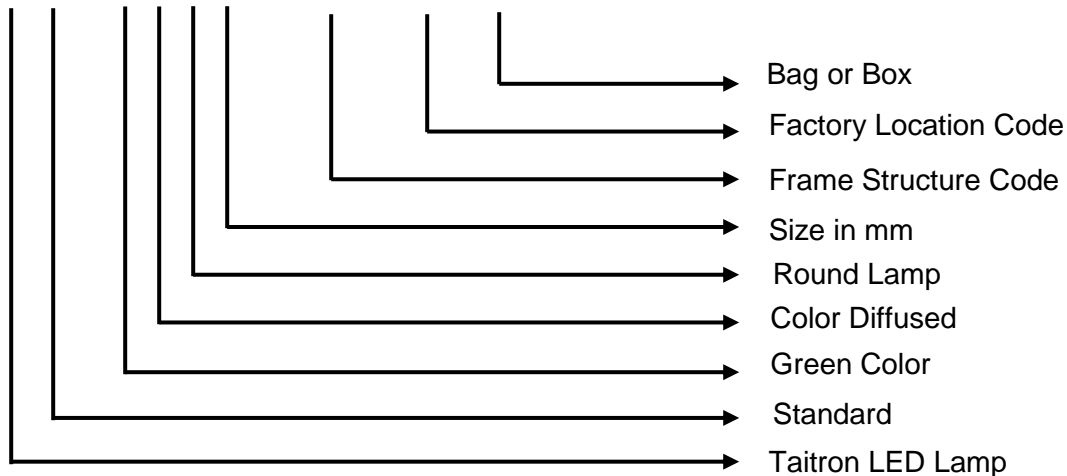

How to contact us

USA HEADQUARTERS

28040 WEST HARRISON PARKWAY, VALENCIA, CA 91355-4162

Tel: (800)-TAITRON (800)-824-8766 (661)-257-6060

Fax: (800)-TAITFAX (800)-824-8329 (661)-257-6415

Email: taitron@taitroncomponents.com

Http://www.taitroncomponents.com

TAITRON COMPONENTS INCORPORATED TAIWAN BRANCH

6F., NO.190, SEC. 2, ZHONGXING RD., XINDIAN DIST., NEW TAIPEI CITY 23146, TAIWAN R.O.C.

Tel: 886-2-2913-6238

Fax: 886-2-2913-6239

TAITRON COMPONENT TECHNOLOG SHANGHAI CORPORATION

SUITE 1503, METROBANK PLAZA, 1160 WEST YAN'AN ROAD, SHANGHAI, 200052, CHINA

Tel: +86-21-5424-9942

Fax: +86-21-2302-5027