

3mm Dome Power LED

Features

- High flux output
- Low profile
- Low thermal resistance
- Design for high current operation
- Packaged in Tubes for use with automatic insertion equipment
- RoHS Compliance



Piranha



Descriptions

- This revolutionary package design allows the light designer to reduce the number of LEDs required and provide a more uniform and unique illuminated appearance than with other LED solutions. This is possible through the efficient optical package design and high-current capabilities.
- The low profile package can be easily coupled with reflectors or lenses to efficiently distribute light and provide the desired light appearance.

Applications

- Automotive Exterior Lighting
- Electronic Signs and Signals
- Channel Letter
- Special Lighting application

Device Selection Guide

Part No.	Chip		Lens Color
	Material	Emitted Color	
TLH-X1W3-3001	AllnGaP	Super Yellow	Water Clear

Absolute Maximum Ratings (Ta=25°C)

Parameter	Symbol	Value	Unit
Reverse Voltage	VR	5	V
Continuous Forward Current	IF	70	mA
Peak Forward Current (Duty 1/10@1KHz)	IFP	160	mA
Power Dissipation	Pd	100	mW
Soldering Temperature (Note.1)	Tsol	260 ± 5	°C
Operating Temperature	Topr	-40 ~ +85	°C
Storage Temperature	Tstg	-40 ~ +100	°C

Note 1: Soldering time ≤ 5 seconds

Electro-Optical Characteristics (Ta=25°C)

Parameter	Symbol	Min.	Typ.	Max.	Unit	Condition
Luminous Flux	Φv	500	1310	-----	mlm	IF =70mA
Viewing Angle	2θ1/2	-----	70	-----	deg	IF =20mA
Peak wavelength	λp	-----	589	-----	nm	
Dominant wavelength	λd	-----	591	-----	nm	
Spectrum Radiation Bandwidth	Δλ	-----	15	-----	nm	
Forward Voltage	VF	1.71	2.30	2.91	V	IF =70mA
Reverse Current	IR	-----	-----	10	μA	VR=5V
Recommend Operating Current	IF(Rec)	20	-----	70	mA	
DC Forward Current	IF(mA)	-----	-----	70	mA	

Notes: Tolerance of Luminous Flux: ±15%

Tolerance of Forward Voltage: ±0.1V

Tolerance of Dominant Wavelength ±1.0nm

Typical Electro-Optical Characteristics Curves (Ta=25°C)

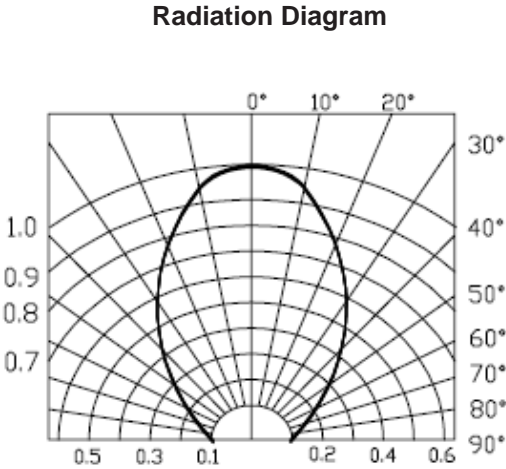
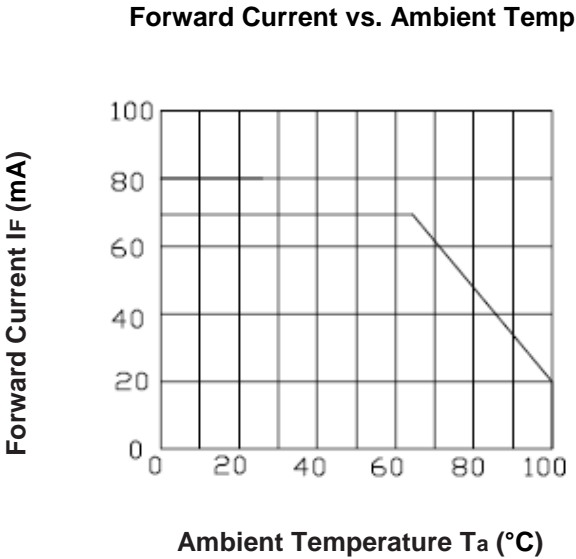
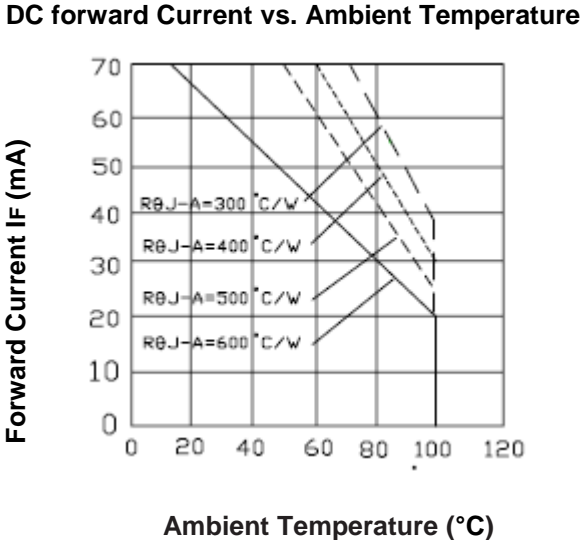
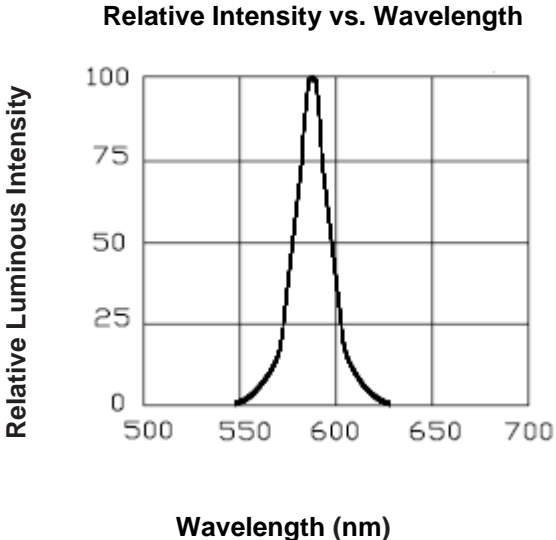

Package Dimensions (In mm)

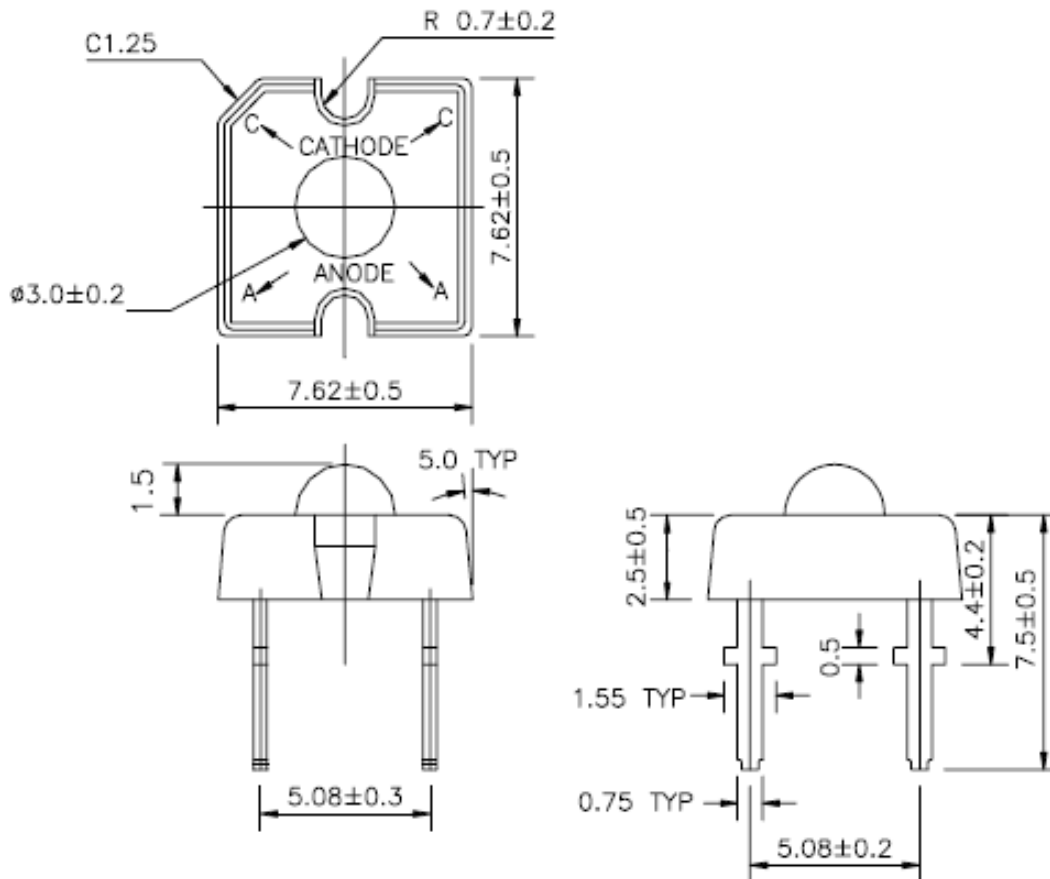

Notes:

1. All dimensions are in millimeters, and tolerance is 0.25mm without special declared.
2. An epoxy meniscus may extend about 1.5mm (0.059") down the lead.

Packing Information

Packing Type	PCS per Tube	PCS Per Inner Box	PCS Per Carton
Tube	60	1,200	14,400

Packing Specification

1. Tube

Cross section image of tube

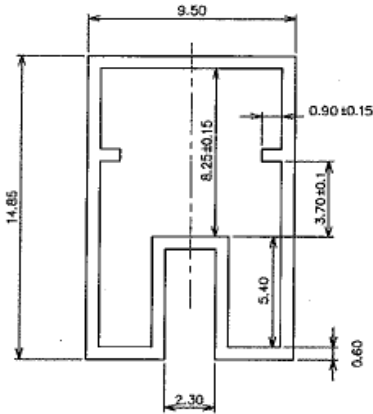

Unit: mm

Whole image of tube

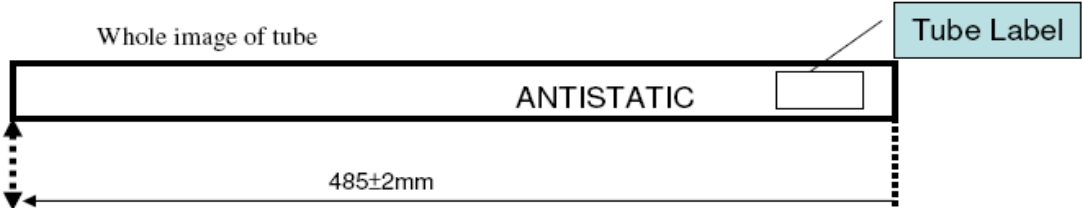

2. Inner Box

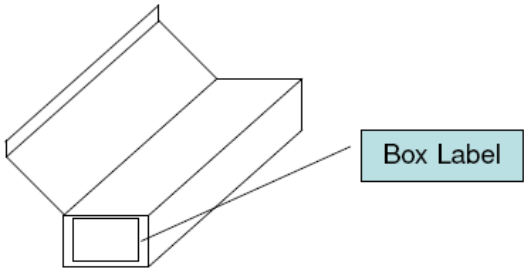

3. Carton (out box)

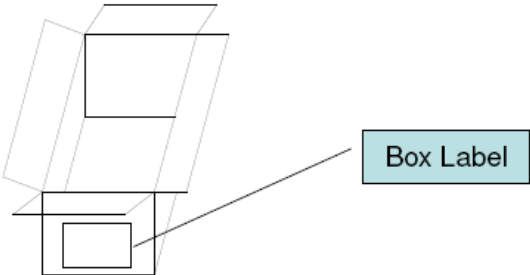

Ordering Information

TL H - X 1 W 3 - 3001 - 92 - TU

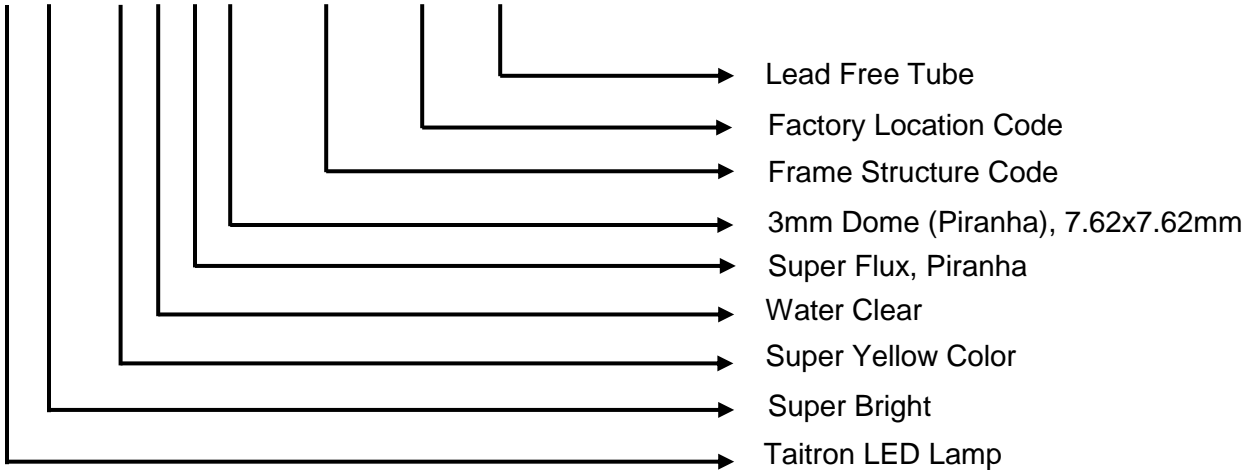

Rank Combinations

Bin Range of Luminous Flux

Bin Code	Min.	Max.	Unit	Condition
U	500	830	mlm	IF=70 mA
V	680	1310		
W	990	1760		
X	1440	2750		
Y	2550	4100		

Bin Range of Dominant Wavelength

Bin Code	Min.	Max.	Unit	Condition
A	585	591	nm	IF=20 mA
B	589	594		
C	592	597		

Bin Range of Forward Voltage

Bin Code	Min.	Max.	Unit	Condition
1	1.71	1.95	V	IF=70 mA
2	1.83	2.07		
3	1.95	2.19		
4	2.07	2.31		
5	2.19	2.43		
6	2.31	2.55		
7	2.43	2.67		
8	2.55	2.79		
9	2.67	2.91		

Notes: Tolerance of Luminous Flux: $\pm 15\%$

How to contact us

USA HEADQUARTERS

28040 WEST HARRISON PARKWAY, VALENCIA, CA 91355-4162

Tel: (800)-TAITRON (800)-824-8766 (661)-257-6060

Fax: (800)-TAITFAX (800)-824-8329 (661)-257-6415

Email: taitron@taitroncomponents.com

Http://www.taitroncomponents.com

TAITRON COMPONENTS INCORPORATED TAIWAN BRANCH

6F., NO.190, SEC. 2, ZHONGXING RD., XINDIAN DIST., NEW TAIPEI CITY 23146, TAIWAN R.O.C.

Tel: 886-2-2913-6238

Fax: 886-2-2913-6239

TAITRON COMPONENT TECHNOLOG SHANGHAI CORPORATION

SUITE 1503, METROBANK PLAZA, 1160 WEST YAN'AN ROAD, SHANGHAI, 200052, CHINA

Tel: +86-21-5424-9942

Fax: +86-21-2302-5027