

**5mm Round LED (T-1 3/4)**

**Features**

- Popular T-1 3/4 diameter package
- Choice of various viewing angles
- Reliable and robust
- RoHS compliance



**T-1 3/4**

**Descriptions**

- The series is specially designed for applications requiring higher brightness.
- The LED lamps are available with different colors, intensities.
- Superior performance in outdoor environment.

**Applications**

- TV set
- Monitor
- Telephone
- Computer

**Device Selection Guide**

Part No.	Chip		Lens Color
	Material	Emitted Color	
TLH-X1R5-3332A3	AllnGaP	Super Yellow	Water Clear

# 5mm Round LED

## TLH-X1R5-3332A3

### Absolute Maximum Ratings (Ta=25°C)

Parameter	Symbol	Value	Unit
Reverse Voltage	<b>VR</b>	5	V
Continuous Forward Current	<b>IF</b>	25	mA
Power Dissipation	<b>Pd</b>	60	mW
Electrostatic Discharge	<b>ESD</b>	2000	V
Soldering Temperature (Note.1)	<b>Tsol</b>	260 ±5	°C
Operating Temperature	<b>Topr</b>	-40 ~ +85	°C
Storage Temperature	<b>Tstg</b>	-40 ~ +100	°C

**Note 1:**

Soldering time ≤ 5 seconds

### Electro-Optical Characteristics (Ta=25°C)

Parameter	Symbol	Min.	Typ.	Max.	Unit	Condition
Luminous Intensity	<b>Iv</b>	1000	2000	-----	mcd	IF =20mA
Viewing Angle	<b>2θ1/2</b>	-----	10	-----	deg	
Peak wavelength	<b>λp</b>	-----	591	-----	nm	
Dominant wavelength	<b>λd</b>	-----	589	-----	nm	
Spectrum Radiation Bandwidth	<b>Δλ</b>	-----	15	-----	nm	
Forward Voltage	<b>VF</b>	-----	2.0	2.4	V	
Reverse Current	<b>IR</b>	-----	-----	10	μA	VR=5V

# 5mm Round LED

## TLH-X1R5-3332A3

### Typical Electro-Optical Characteristics Curves (Ta=25°C)

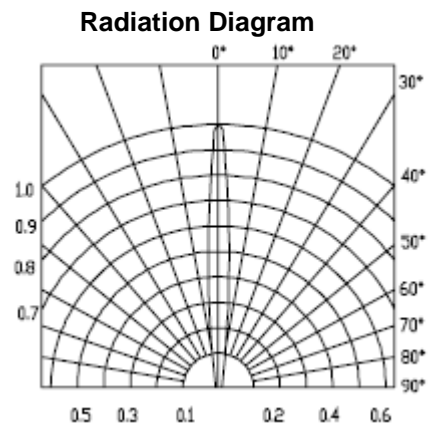
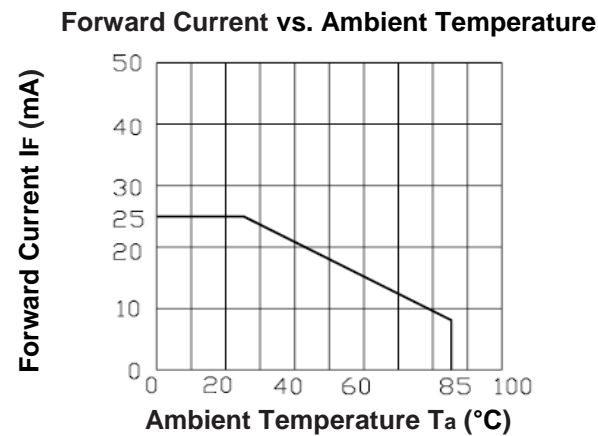
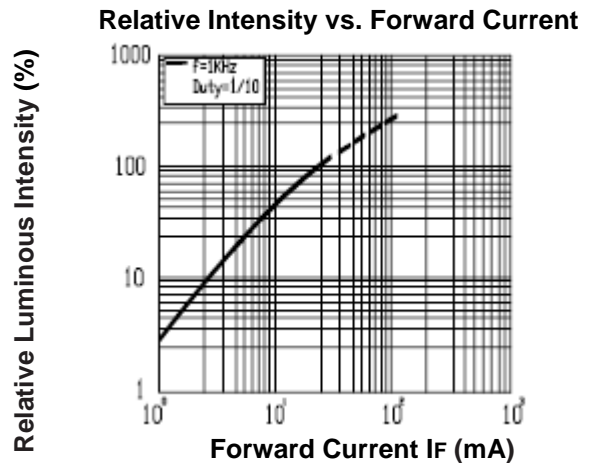
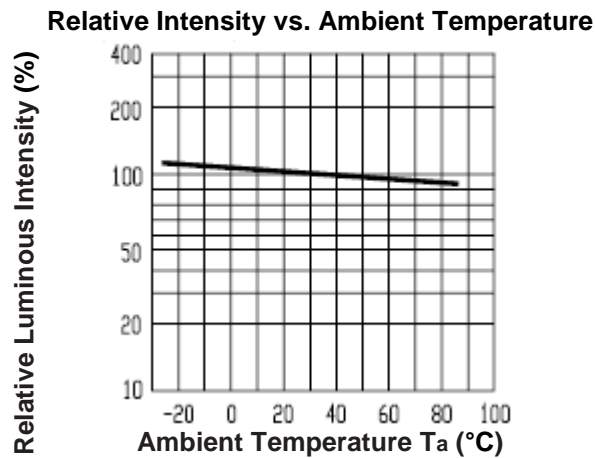
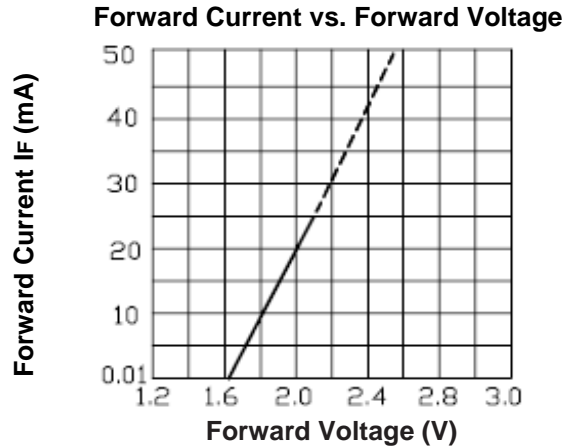
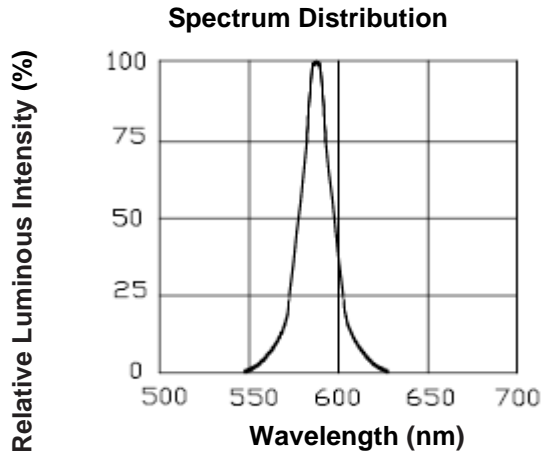

# 5mm Round LED

## TLH-X1R5-3332A3

### Package Dimensions (In mm)

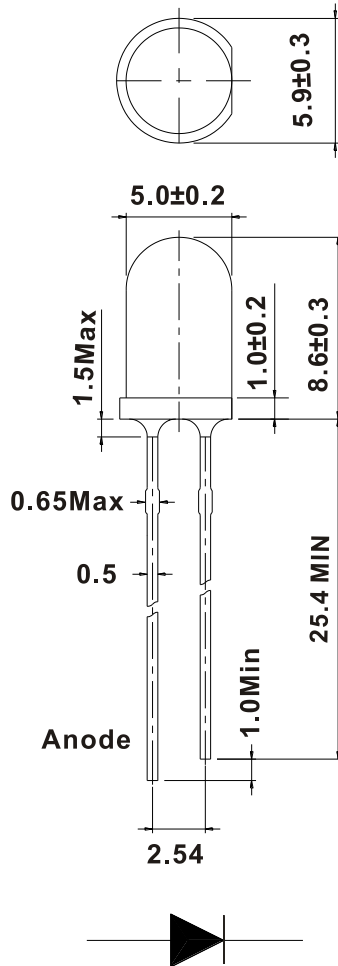

#### Note:

1. All dimensions are in millimeters, and tolerance is 0.25mm without special declared.
2. An epoxy meniscus may extend about 1.5mm down the lead.

### Packing Quantity Specification

Packing Type	PCS per Bag	PCS Per Inner Box	PCS Per Carton
Bulk	500	2,500	25,000

# 5mm Round LED

## TLH-X1R5-3332A3

### Ordering Information

TL H - X 1 R 5 - 3332 A3 - 92 - BL

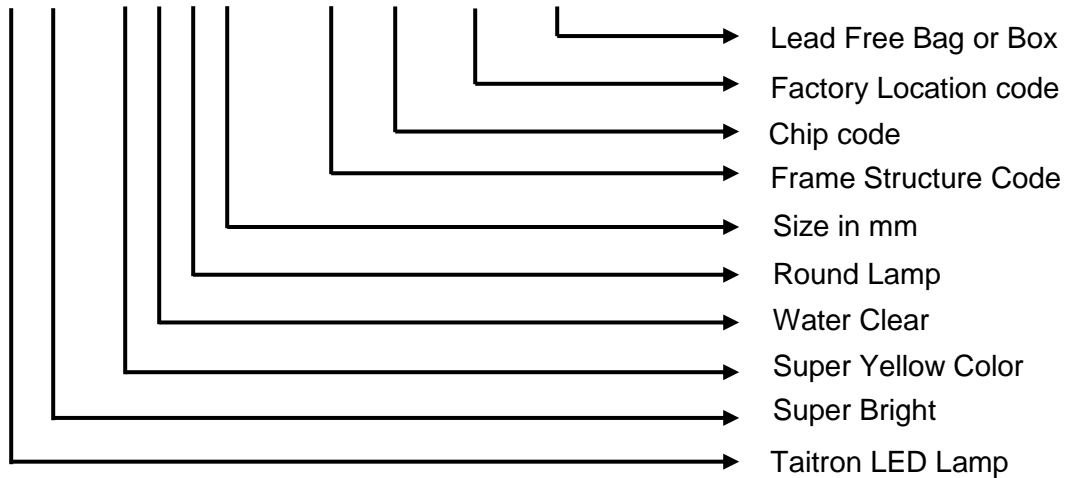

### Label Explanation

**CAT:** Ranks

**HUE:** Dominant Wavelength Rank

**REF:** Reference

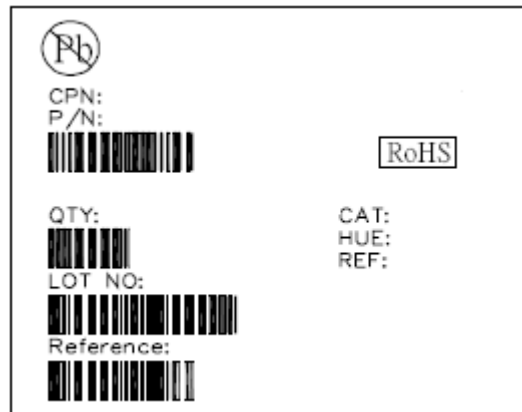

## How to contact us

### **USA HEADQUARTERS**

28040 WEST HARRISON PARKWAY, VALENCIA, CA 91355-4162

Tel: (800)-TAITRON (800)-824-8766 (661)-257-6060

Fax: (800)-TAITFAX (800)-824-8329 (661)-257-6415

Email: [taitron@taitroncomponents.com](mailto:taitron@taitroncomponents.com)

Http://[www.taitroncomponents.com](http://www.taitroncomponents.com)

### **TAITRON COMPONENTS INCORPORATED TAIWAN BRANCH**

6F., NO.190, SEC. 2, ZHONGXING RD., XINDIAN DIST., NEW TAIPEI CITY 23146, TAIWAN R.O.C.

Tel: 886-2-2913-6238

Fax: 886-2-2913-6239

### **TAITRON COMPONENT TECHNOLOG SHANGHAI CORPORATION**

SUITE 1503, METROBANK PLAZA, 1160 WEST YAN'AN ROAD, SHANGHAI, 200052, CHINA

Tel: +86-21-5424-9942

Fax: +86-21-2302-5027