

5mm Round LED (T-1 3/4)

Features

- Popular T-1 3/4 diameter package
- Choice of various viewing angles
- Reliable and robust
- RoHS compliance



T-1 3/4



Descriptions

- The series is specially designed for applications requiring higher brightness.
- The LED lamps are available with different colors, intensities.

Applications

- TV set
- Monitor
- Telephone
- Computer

Device Selection Guide

Part No.	Chip		Lens Color
	Material	Emitted Color	
TLH-T4R5-3332X6	InGaN	True Green	Color Diffused

5mm Round LED

TLH-T4R5-3332X6

Absolute Maximum Ratings (Ta=25°C)

Parameter	Symbol	Value	Unit
Reverse Voltage	VR	5	V
Continuous Forward Current	IF	25	mA
Peak Forward Current	IFP	100	mA
Power Dissipation	Pd	110	mW
Electrostatic Discharge	ESD	150	V
Soldering Temperature (Note.1)	Tsol	260 ± 5	°C
Operating Temperature	Topr	-40 ~ +85	°C
Storage Temperature	Tstg	-40 ~ +100	°C

Note 1:

Soldering time ≤ 5 seconds

Electro-Optical Characteristics (Ta=25°C)

Parameter	Symbol	Min.	Typ.	Max.	Unit	Condition
Luminous Intensity	Iv	2500	5000	-----	mcd	IF =20mA
Viewing Angle	2θ1/2	-----	20	-----	deg	
Peak wavelength	λp	-----	525	-----	nm	
Dominant wavelength	λd	-----	530	-----	nm	
Spectrum Radiation Bandwidth	Δλ	-----	35	-----	nm	
Forward Voltage	VF	-----	3.4	4.0	V	
Reverse Current	IR	-----	-----	50	μA	VR=5V

5mm Round LED

TLH-T4R5-3332X6

Typical Electro-Optical Characteristics Curves (Ta=25°C)

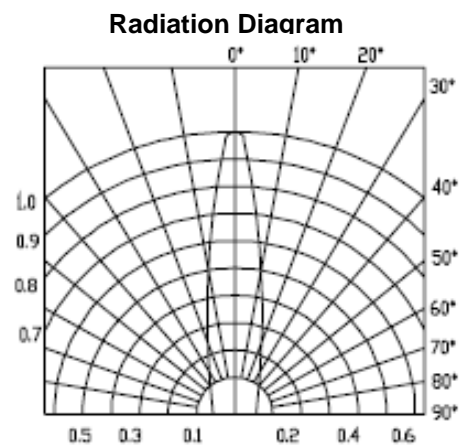
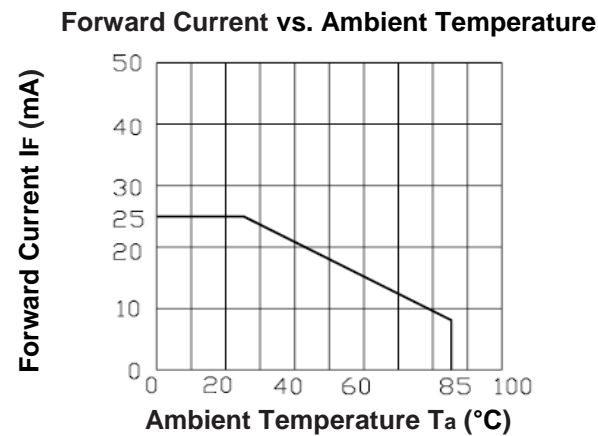
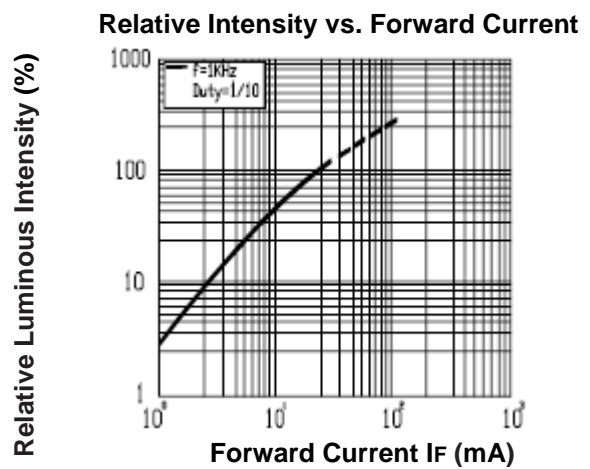
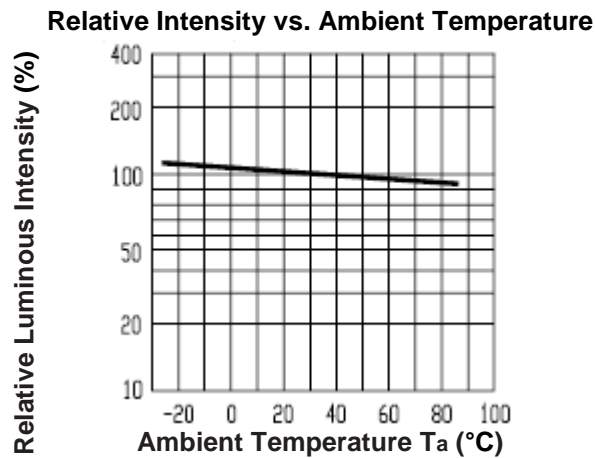
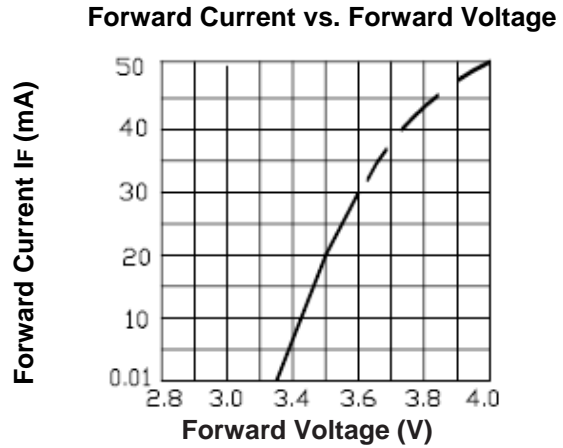
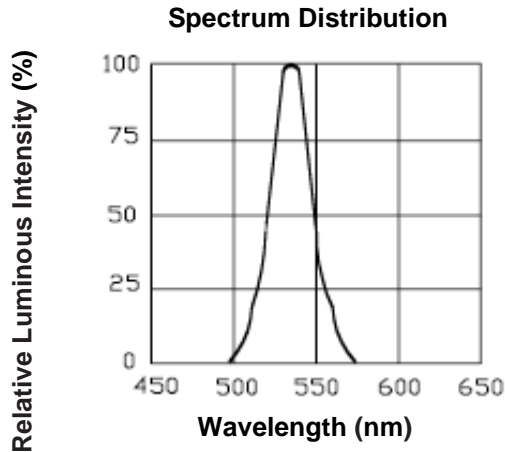

5mm Round LED

TLH-T4R5-3332X6

Package Dimensions (In mm)

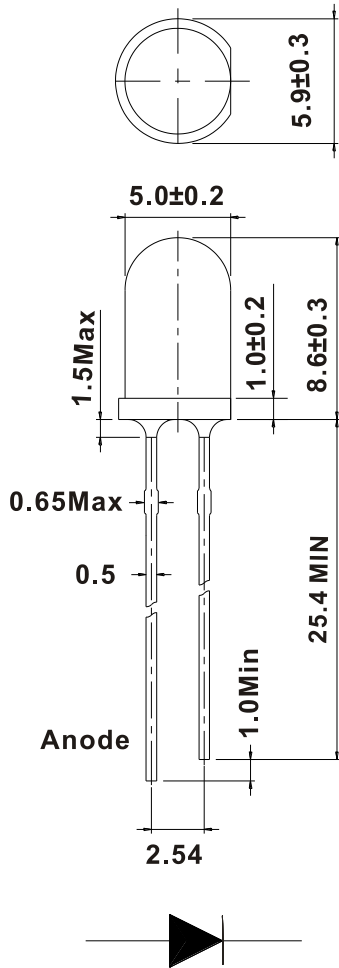

Note:

1. All dimensions are in millimeters, and tolerance is 0.25mm without special declared.
2. An epoxy meniscus may extend about 1.5mm down the lead.

Packing Quantity Specification

Packing Type	PCS per Bag	PCS Per Inner Box	PCS Per Carton
Bulk	500	2,500	25,000

5mm Round LED

TLH-T4R5-3332X6

Ordering Information

TL H - T 4 R 5 - 3332 X6 - 92 - BL

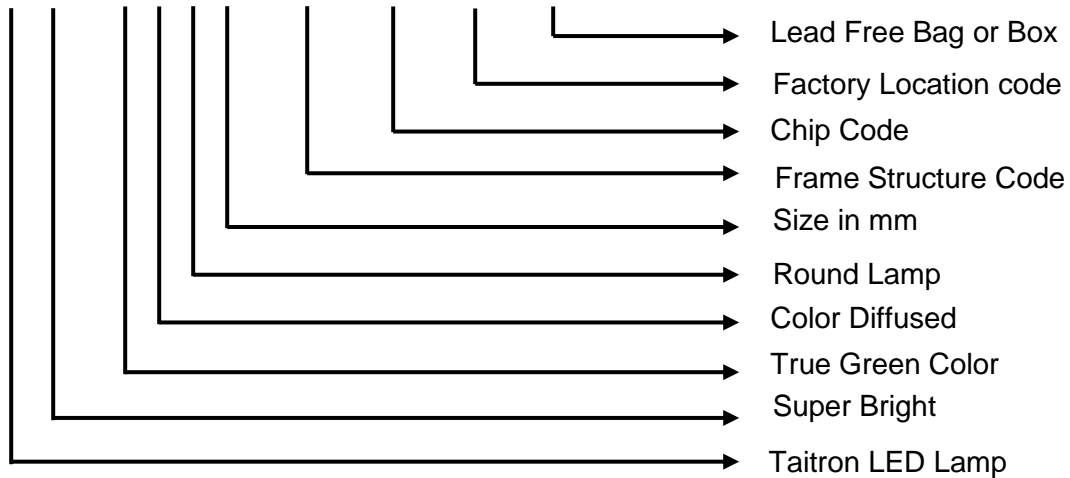

Label Explanation

CAT: Ranks

HUE: Dominant Wavelength Rank

REF: Reference

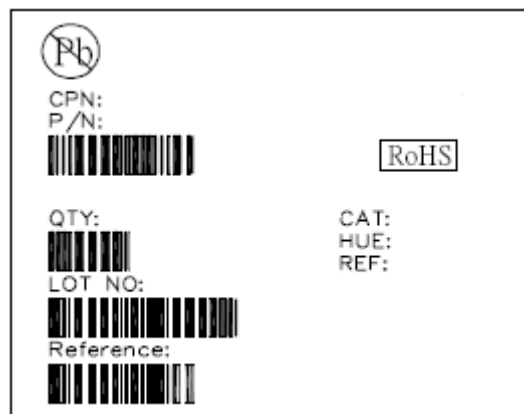

How to contact us

USA HEADQUARTERS

28040 WEST HARRISON PARKWAY, VALENCIA, CA 91355-4162

Tel: (800)-TAITRON (800)-824-8766 (661)-257-6060

Fax: (800)-TAITFAX (800)-824-8329 (661)-257-6415

Email: taitron@taitroncomponents.com

Http://www.taitroncomponents.com

TAITRON COMPONENTS INCORPORATED TAIWAN BRANCH

6F., NO.190, SEC. 2, ZHONGXING RD., XINDIAN DIST., NEW TAIPEI CITY 23146, TAIWAN R.O.C.

Tel: 886-2-2913-6238

Fax: 886-2-2913-6239

TAITRON COMPONENT TECHNOLOG SHANGHAI CORPORATION

SUITE 1503, METROBANK PLAZA, 1160 WEST YAN'AN ROAD, SHANGHAI, 200052, CHINA

Tel: +86-21-5424-9942

Fax: +86-21-2302-5027