

5mm Round LED (T-1 3/4)

Features

- Popular T-1 3/4 diameter package
- Choice of various viewing angles
- Reliable and robust
- RoHS compliance



T-1 3/4



Descriptions

- The series is specially designed for applications requiring higher brightness.
- The LED lamps are available with different colors, intensities.

Applications

- TV set
- Monitor
- Telephone
- Computer

Device Selection Guide

| Part No. | Chip | | Lens Color |
|-----------------|----------|---------------|-------------|
| | Material | Emitted Color | |
| TLH-T1R5-3332B5 | InGaN | True Green | Water Clear |

5mm Round LED

TLH-T1R5-3332B5

Absolute Maximum Ratings (Ta=25°C)

| Parameter | Symbol | Value | Unit |
|--------------------------------|-------------|------------|------|
| Reverse Voltage | VR | 5 | V |
| Continuous Forward Current | IF | 25 | mA |
| Power Dissipation | Pd | 110 | mW |
| Electrostatic Discharge | ESD | 150 | V |
| Soldering Temperature (Note.1) | Tsol | 260 ±5 | °C |
| Operating Temperature | Topr | -40 ~ +85 | °C |
| Storage Temperature | Tstg | -40 ~ +100 | °C |

Note 1:

Soldering time ≤ 5 seconds

Electro-Optical Characteristics (Ta=25°C)

| Parameter | Symbol | Min. | Typ. | Max. | Unit | Condition |
|------------------------------|--------------|-------|-------|-------|------|-----------|
| Luminous Intensity | Iv | 4000 | 8000 | ----- | mcd | IF =20mA |
| Viewing Angle | 2θ1/2 | ----- | 15 | ----- | deg | |
| Peak wavelength | λp | ----- | 525 | ----- | nm | |
| Dominant wavelength | λd | ----- | 530 | ----- | nm | |
| Spectrum Radiation Bandwidth | Δλ | ----- | 35 | ----- | nm | |
| Forward Voltage | VF | ----- | 3.4 | 4.0 | V | |
| Reverse Current | IR | ----- | ----- | 50 | μA | VR=5V |

5mm Round LED

TLH-T1R5-3332B5

Typical Electro-Optical Characteristics Curves (Ta=25°C)

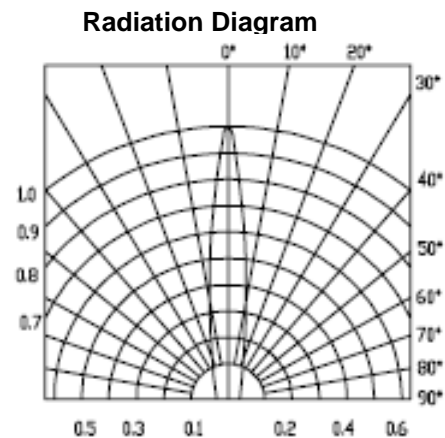
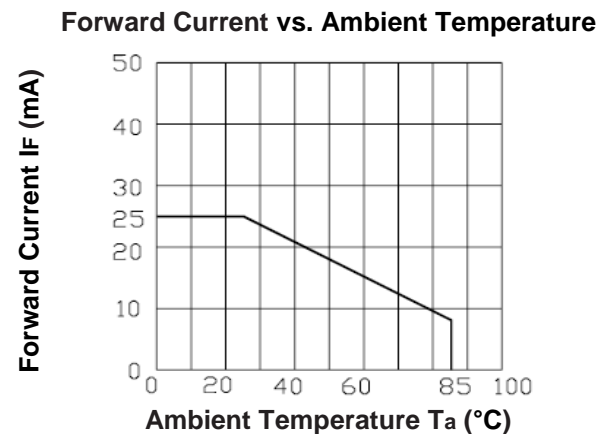
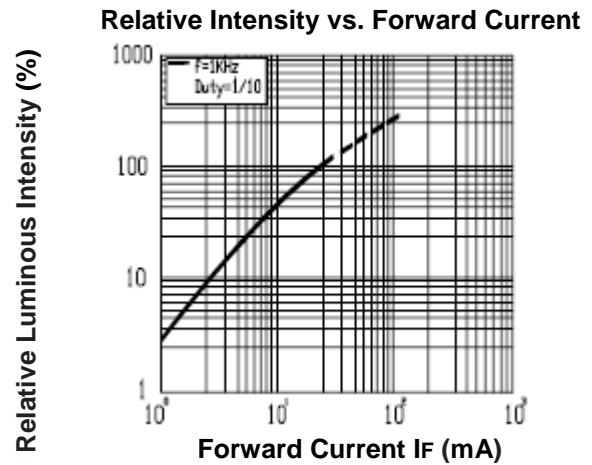
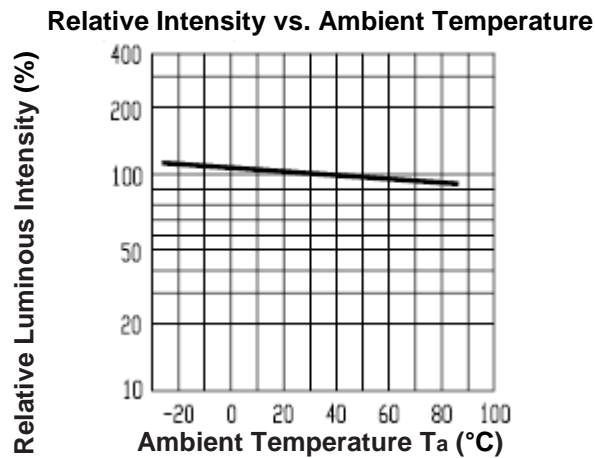
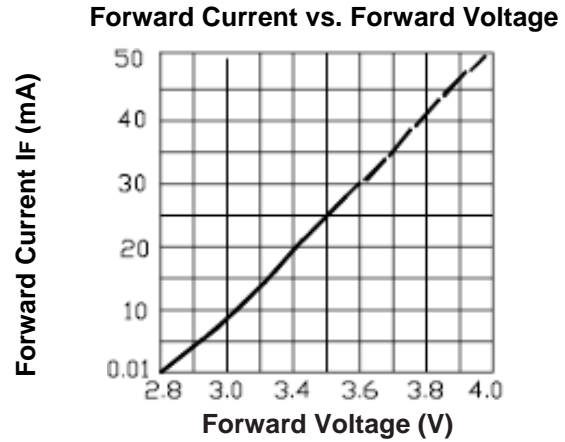
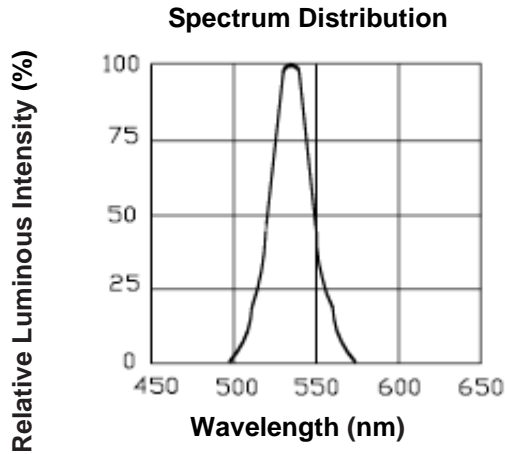

5mm Round LED

TLH-T1R5-3332B5

Package Dimensions (In mm)

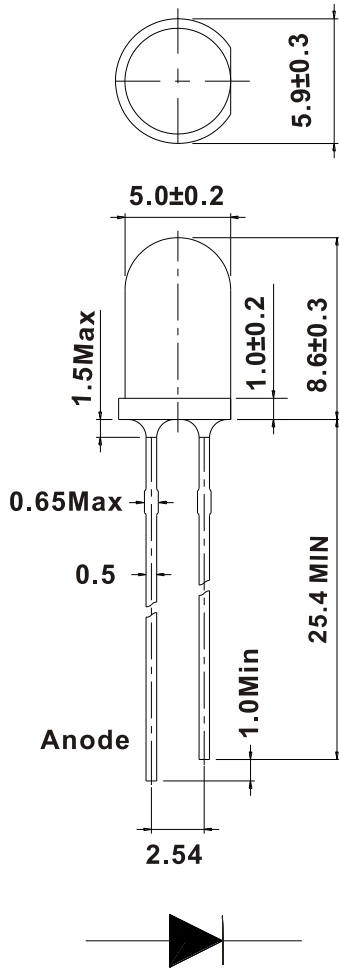

Note:

1. All dimensions are in millimeters, and tolerance is 0.25mm without special declared.
2. An epoxy meniscus may extend about 1.5mm down the lead.

Packing Quantity Specification

| Packing Type | PCS per Bag | PCS Per Inner Box | PCS Per Carton |
|--------------|-------------|-------------------|----------------|
| Bulk | 500 | 2,500 | 25,000 |

5mm Round LED

TLH-T1R5-3332B5

Ordering Information

TL H - T 1 R 5 - 3332 B5 - 92 - BL

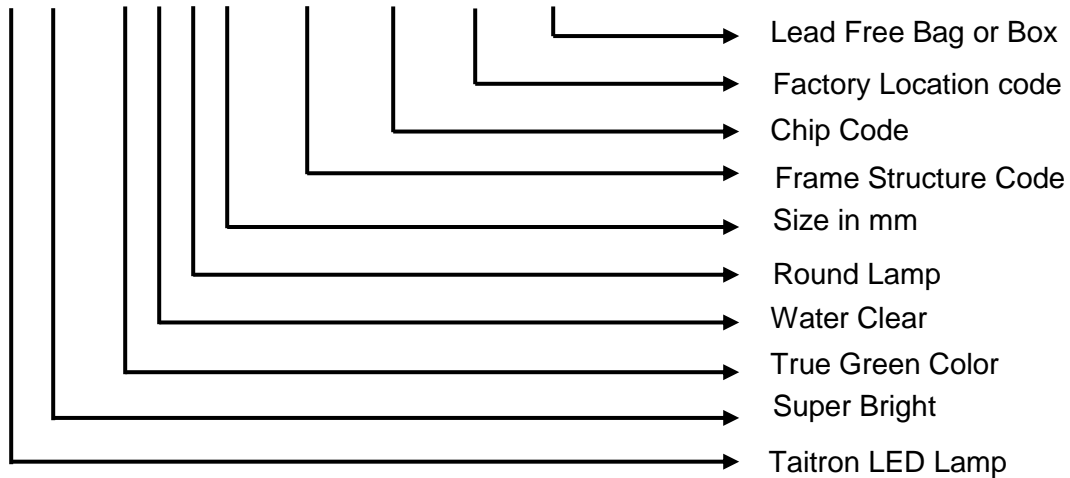

Label Explanation

CAT: Ranks

HUE: Peak Wavelength Rank

REF: Reference

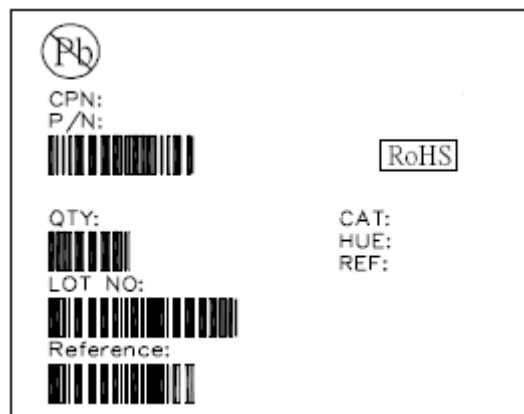

How to contact us

USA HEADQUARTERS

28040 WEST HARRISON PARKWAY, VALENCIA, CA 91355-4162

Tel: (800)-TAITRON (800)-824-8766 (661)-257-6060

Fax: (800)-TAITFAX (800)-824-8329 (661)-257-6415

Email: taitron@taitroncomponents.com

Http://www.taitroncomponents.com

TAITRON COMPONENTS INCORPORATED TAIWAN BRANCH

6F., NO.190, SEC. 2, ZHONGXING RD., XINDIAN DIST., NEW TAIPEI CITY 23146, TAIWAN R.O.C.

Tel: 886-2-2913-6238

Fax: 886-2-2913-6239

TAITRON COMPONENT TECHNOLOG SHANGHAI CORPORATION

SUITE 1503, METROBANK PLAZA, 1160 WEST YAN'AN ROAD, SHANGHAI, 200052, CHINA

Tel: +86-21-5424-9942

Fax: +86-21-2302-5027