

4A Bridge Rectifier

Features

- Ideal for printed circuit boards
- Low forward voltage drop
- High current capability
- High reliability
- High surge current capability
- High temperature soldering guaranteed: 260°C/10 seconds
/.375"(9.5mm) lead length at 5lbs., (2.3kg) tension
- This series is UL recognized under component index, File number E194718
- RoHS Compliant

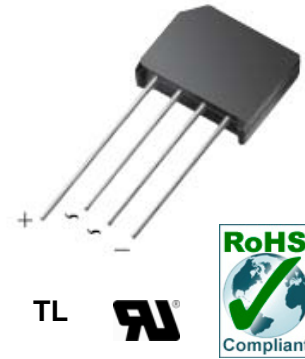

Mechanical Data

Case:	TL, molded plastic
Epoxy:	Plastic package has UL flammability 94V-0
Terminals:	Plated leads solderable per MIL-STD-202, Method 208
Polarity:	As marked on body
Weight:	5.6 gram

Maximum Ratings And Electrical Characteristics (T_{amb}=25°C)

Symbol	Description	TL400	TL401	TL402	TL404	TL406	TL408	TL410	Unit	Conditions
		KBL005	KBL01	KBL02	KBL04	KBL06	KBL08	KBL10		
	Marking Code	TL400 KBL005	TL401 KBL01	TL402 KBL02	TL404 KBL04	TL406 KBL06	TL408 KBL08	TL410 KBL10		
VRRM	Max. Repetitive Peak Reverse Voltage	50	100	200	400	600	800	1000	V	
VRMS	Max. RMS Voltage	35	70	140	280	420	560	700	V	
VDC	Max. DC Blocking Voltage	50	100	200	400	600	800	1000	V	
IF(AV)	Max. Average Forward Current	4.0							A	TA=50°C
IFSM	Peak Forward Surge Current	200							A	8.3ms single half sine-wave superimposed on rated load (JEDEC Method)

4A Bridge Rectifier

TL400 - TL410/KBL005 - KBL10

Symbol	Description	TL400	TL401	TL402	TL404	TL406	TL408	TL410	Unit	Conditions
		KBL005	KBL01	KBL02	KBL04	KBL06	KBL08	KBL10		
V _F	Max. Instantaneous Forward Voltage drop per leg	1.1							V	I _F =4.0A
I _R	Maximum DC Reverse Current at Rated DC Blocking Voltage per leg	5.0							μA	T _A =25°C
		1.0							mA	T _A =125°C
I _t	Rating for Fusing (t<8.3ms)	166							A ² s	Note 1
R _{thJA}	Typical Thermal Resistance per leg	19							°C / W	Note 2
R _{thJL}		2.4								Note 3
T _J , T _{STG}	Operating Junction and Storage Temperature Range	-50 to +150							°C	

Note: 1. Non-repetitive for t > 1ms and < 8.3ms.

2. Thermal resistance from junction to ambient with units mounted on 3.0 x 3.0 x 0.11" thick (75 x 75 x 3.0mm) Al. plate.

3. Thermal resistance from junction to lead with units mounted on P.C.B. at 0.375" (9.5mm) lead length with 0.5 x 0.5" (12 x 12mm) copper pads.

Typical Characteristics Curves

Fig.1-Max. Forward Current Derating Curve

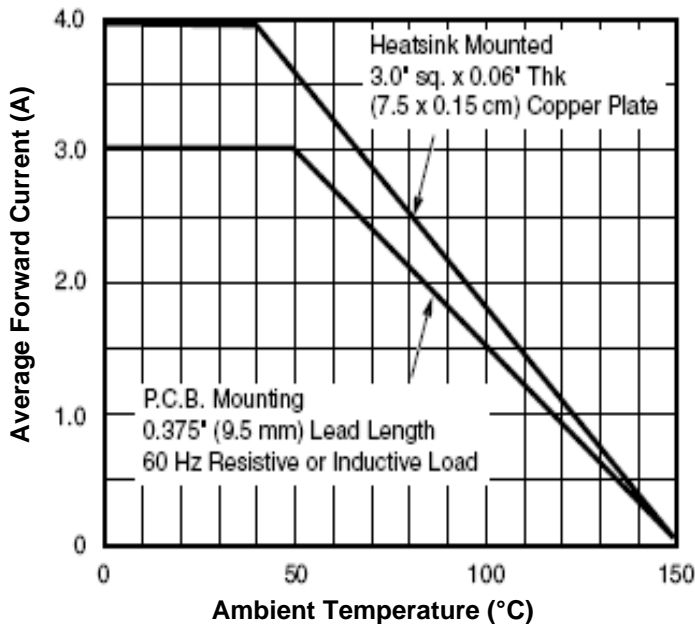
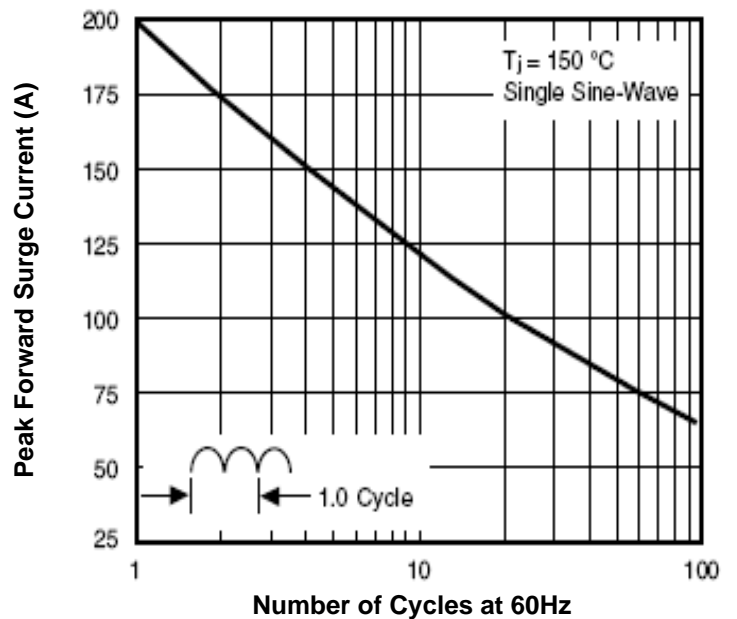

Fig.2-Max. Non-repetitive Peak Forward Surge Current per leg



TL400 - TL410/KBL005 - KBL10

Fig.3-Typical Instantaneous Forward Characteristic per leg

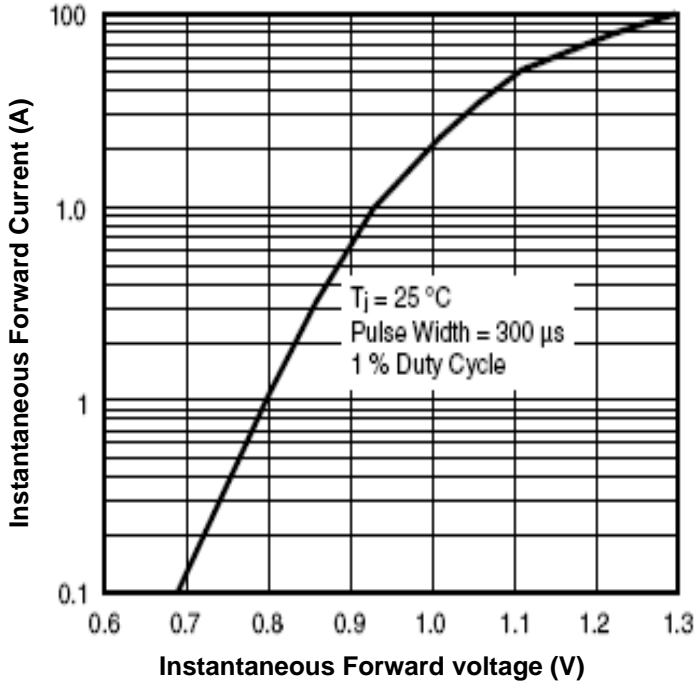

Fig.4-Typical Reverse Characteristics per leg

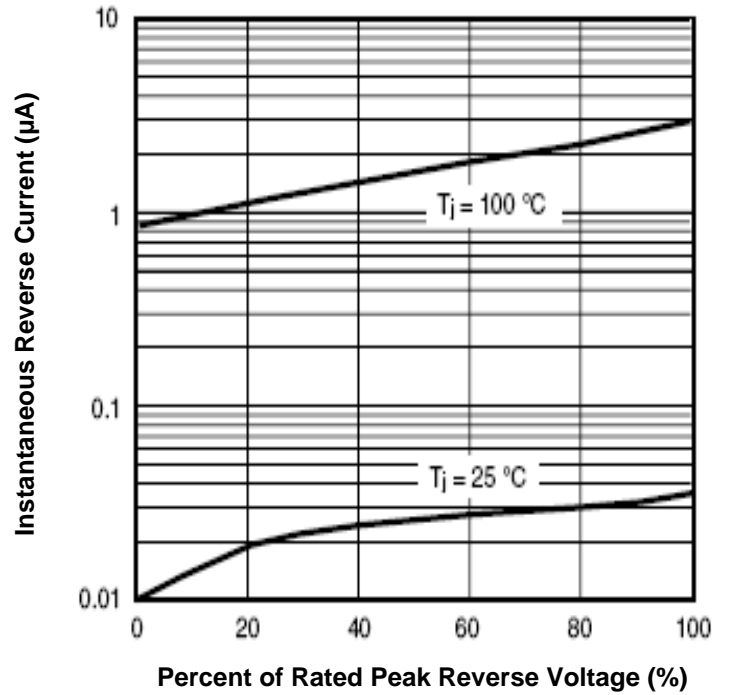
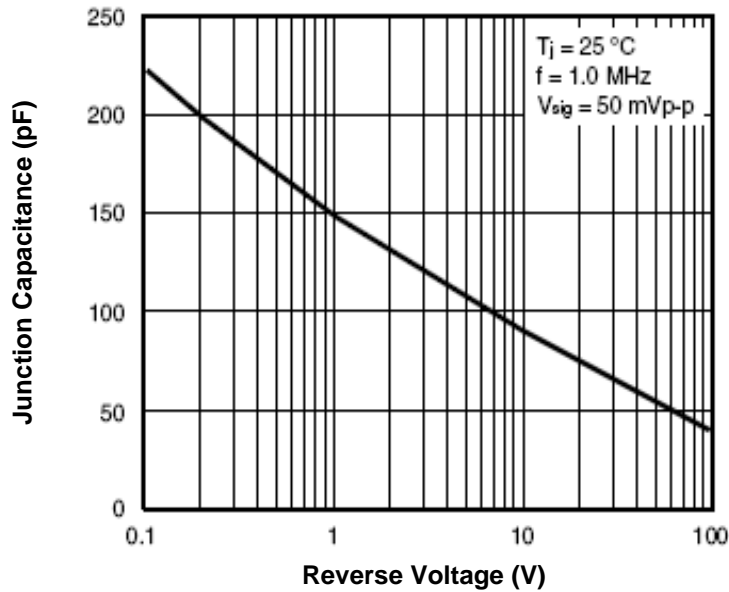
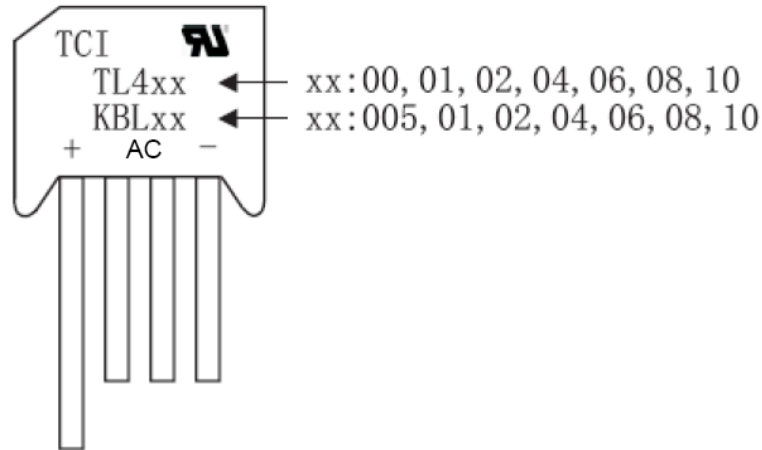

Fig.5- Typical Junction Capacitance per leg



TL400 - TL410/KBL005 - KBL10

Marking Information:



Dimensions in mm

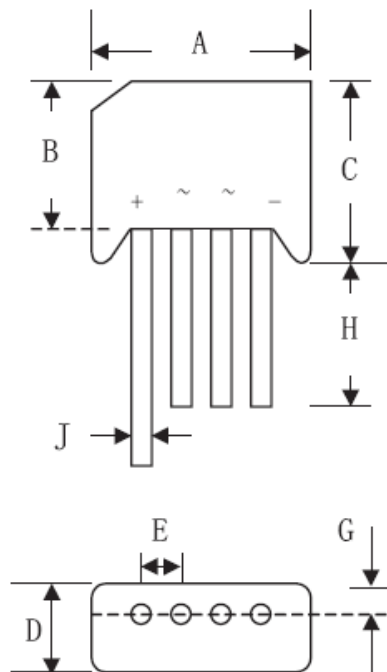

Dim	Min	Max
A	18.50	19.50
B	13.70	14.70
C	15.20	16.30
D	6.00	6.50
E	4.60	5.60
G	—	2.10
H	19.00	—
J	1.20 Ø	1.30 Ø

TL

How to contact us

USA HEADQUARTERS

28040 WEST HARRISON PARKWAY, VALENCIA, CA 91355-4162

Tel: (800)-TAITRON (800)-824-8766 (661)-257-6060

Fax: (800)-TAITFAX (800)-824-8329 (661)-257-6415

Email: taitron@taitroncomponents.com

Http://www.taitroncomponents.com

TAITRON COMPONENTS INCORPORATED TAIWAN BRANCH

6F., NO.190, SEC. 2, ZHONGXING RD., XINDIAN DIST., NEW TAIPEI CITY 23146, TAIWAN R.O.C.

Tel: 886-2-2913-6238

Fax: 886-2-2913-6239

TAITRON COMPONENT TECHNOLOG SHANGHAI CORPORATION

SUITE 1503, METROBANK PLAZA, 1160 WEST YAN'AN ROAD, SHANGHAI, 200052, CHINA

Tel: +86-21-5424-9942

Fax: +86-21-2302-5027