

25.0A Single-Phase Bridge Rectifier

Features

- High forward surge current capability
- Ideal for printed circuit board
- High temperature soldering guaranteed:
260°C/10 seconds, 5 lbs (2.3kg) tension

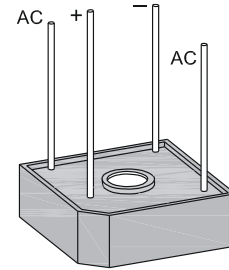

TB35W 

Mechanical Data

Case:	Molded plastic body with Metal Heat Sink
Polarity:	Polarity symbols marked on case
Terminals:	Plated 0.25" (6.35mm) lug
Mounting Position:	Thru hole for #10 screw, 20 in -lbs. torque max
Weight:	0.53 ounce, 15 grams

Maximum Ratings & Electrical Characteristics ($T_{Ambient}=25^{\circ}C$ unless noted otherwise)

Symbols	Description	TB2505W	TB251W	TB252W	TB254W	TB256W	TB258W	TB2510W	Unit
VRRM	Max. recurrent peak reverse voltage	50	100	200	400	600	800	1000	V
VRMS	Max. RMS voltage	35	70	140	280	420	560	700	V
VDC	Max. DC blocking voltage	50	100	200	400	600	800	1000	V
Io(AV)	Max. average forward rectified current @ $T_C=50^{\circ}C$	25.0							A
IFSM	Peak forward surge current (JEDEC)	300							A
I²t	Rating for Fusing (t<8.3ms)	375							A ² sec
VISO	Isolation Voltage from case to lugs	2500							V
Cj	Typical Capacitance Junction(per element)(Note 2)	300							pF
TJ	Operating junction temperature range	-65 to +150							°C
TSTG	Storage Temperature Range	-65 to +150							°C

25.0A SINGLE-PHASE BRIDGE RECTIFIER

TB2505W -TB2510W

Symbol	Description	TB2505W	TB251W	TB252W	TB254W	TB256W	TB258W	TB2510W	Unit	
V_F	Maximum Instantaneous Forward Voltage Drop Per Leg@12.5 A	1.1								V
I_R	Maximum DC Reverse Current Rated DC Blocking Voltage	T _A =25° C		10.0						uA
		T _A =100° C		500						uA
R_{θ-JC}	Maximum Thermal Resistance (Note 3)	2.0								°C/W

NOTES:

1. 8.3ms single half sine-wave superimposed on rated load (JEDEC method).
2. Measured at 1MHz and applied reverse voltage of 4.0Volts D.C.
3. Thermal resistance junction to case mounted on heat sink.

Typical Characteristics Curves

Fig.1- Typical Forward Current Derating Curve

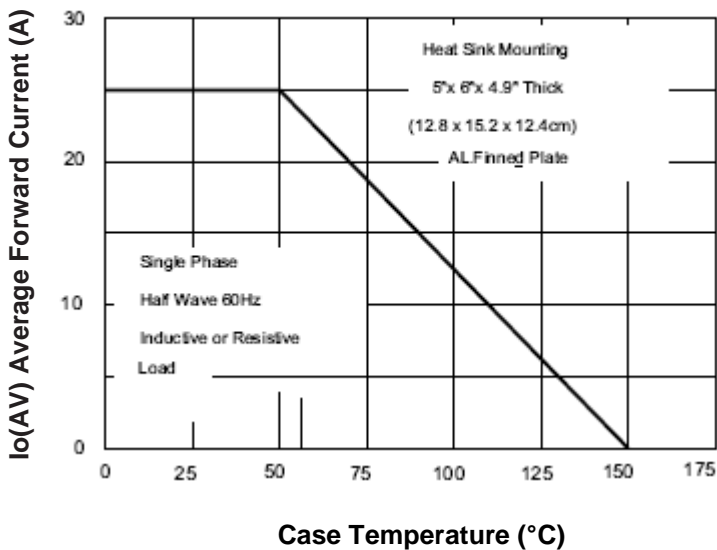
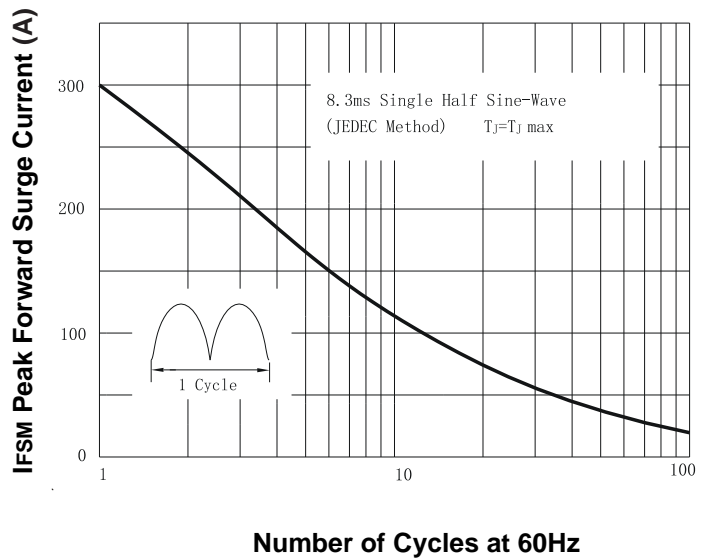

Fig.2-Max. Non-repetitive Peak Forward Surge Current



25.0A SINGLE-PHASE BRIDGE RECTIFIER

TB2505W -TB2510W

Fig.3- Typical Instantaneous Forward Characteristics

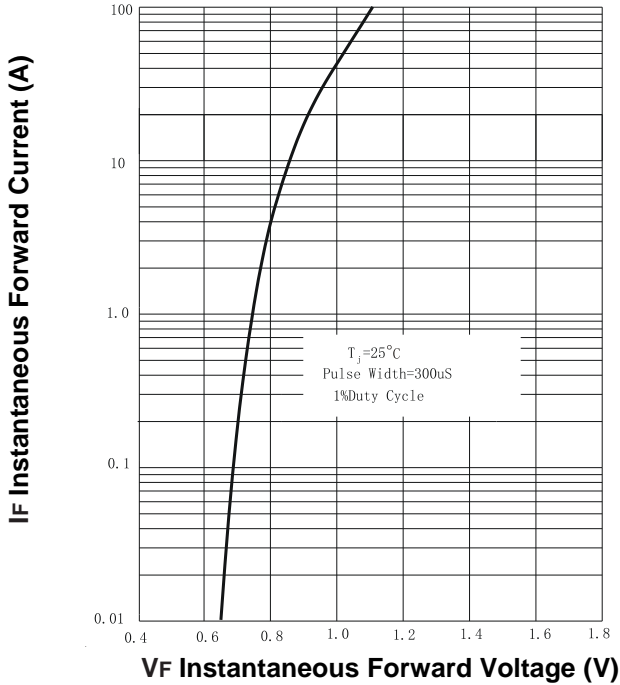

Fig.4- Typical Reverse Characteristics

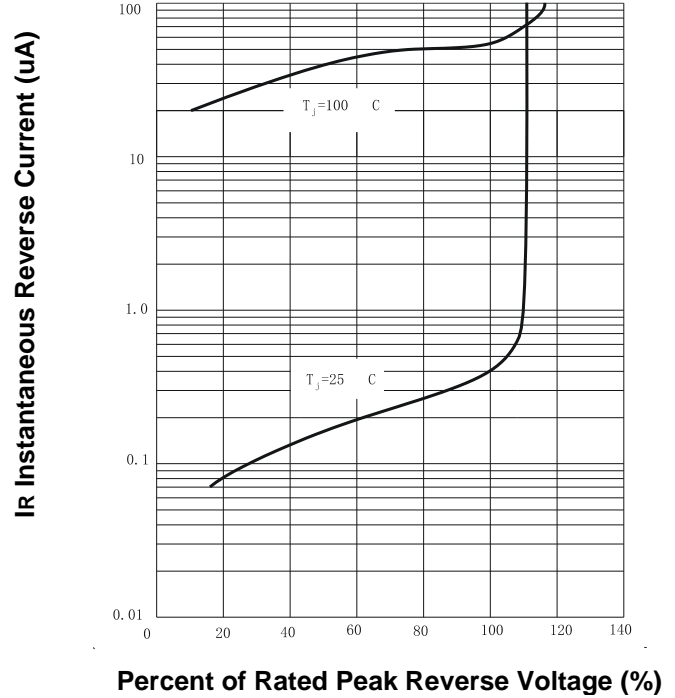
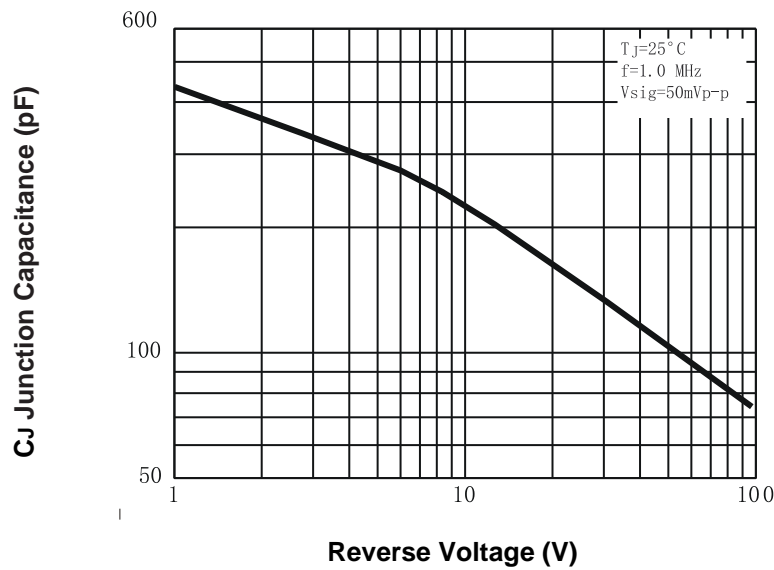

Fig.5-Typical junction capacitance



25.0A SINGLE-PHASE BRIDGE RECTIFIER

TB2505W -TB2510W

Dimensions in inches (mm)

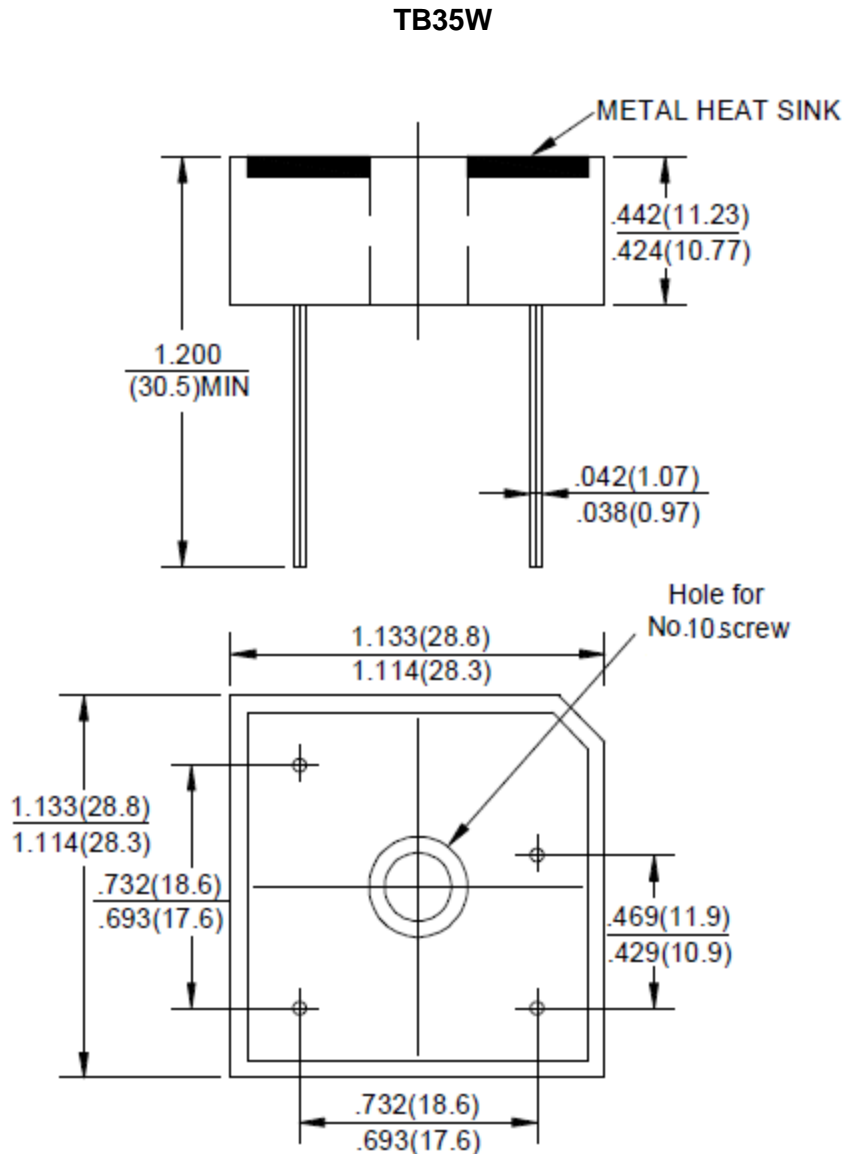

25.0A SINGLE-PHASE BRIDGE RECTIFIER

TB2505W -TB2510W

How to contact us

USA HEADQUARTERS

28040 WEST HARRISON PARKWAY, VALENCIA, CA 91355-4162

Tel: (800)-TAITRON (800)-824-8766 (661)-257-6060

Fax: (800)-TAITFAX (800)-824-8329 (661)-257-6415

Email: taitron@taitroncomponents.com

Http://www.taitroncomponents.com

TAITRON COMPONENTS INCORPORATED TAIWAN BRANCH

6F., NO.190, SEC. 2, ZHONGXING RD., XINDIAN DIST., NEW TAIPEI CITY 23146, TAIWAN R.O.C.

Tel: 886-2-2913-6238

Fax: 886-2-2913-6239

TAITRON COMPONENT TECHNOLOG SHANGHAI CORPORATION

SUITE 1503, METROBANK PLAZA, 1160 WEST YAN'AN ROAD, SHANGHAI, 200052, CHINA

Tel: +86-21-5424-9942

Fax: +86-21-2302-5027