

Two Terminals Surface Mount Switching Diodes

Features

- Fast Switching Speed
- Surface Mount Package Ideally Suited for Automatic Insertion
- General Purpose Rectification
- Silicon Epitaxial Planar Construction
- RoHS compliant

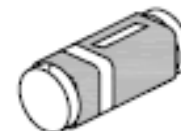

QuadromELF



Mechanical Data

Case:	QuadromELF, Glass Case
Terminals:	Solderable per MIL-STD-750, Method 2026
Weight:	0.03 grams

Maximum Ratings ($T_{Ambient}=25^{\circ}C$ unless noted otherwise)

Symbol	Description	LS4148	Unit	Conditions
V_{RM}	Reverse Voltage	75	V	
V_{RRM}	Peak Reverse Voltage	100	V	
I_{F(AV)}	Forward Average Current	150	mA	T _a =25°C, f ≥ 50Hz
I_{FSM}	Peak Forward Surge Current	500	mA	T _J =25°C, t < 1s
P_D	Power Dissipation	500	mW	T _a =25°C
V_F	Max. Forward Voltage	1.0	V	I _F =10mA
I_R	Max. Reverse Current	0.025	μA	V _R =20V
		5.0		V _R =75V
		50		V _R =20V, T _J =150°C
C_J	Max. Capacitance	4.0	pF	V _R =V _F =0V
T_{rr}	Max. Reverse Recovery Time	4.0	ns	I _F =-I _R =10mA to I _{RR} =-1mA, V _R =6V, R _L =100Ω
R_{θJA}	Typical Thermal Resistance	300	°C/W	
T_J, T_{STG}	Operating Junction and Storage Temperature Range	-65 to +175	°C	

Typical Characteristics Curves

Fig.1- Forward Power Dissipation Derating Curve

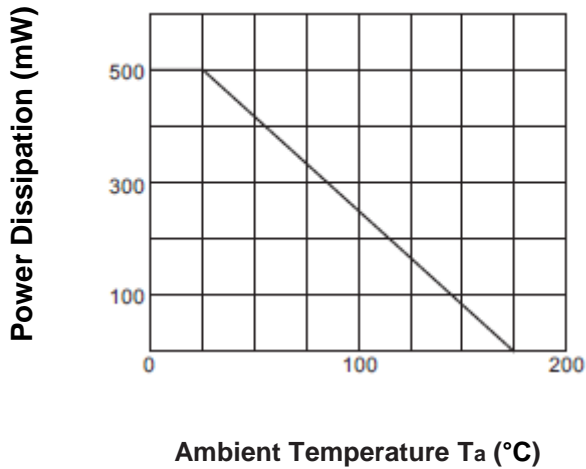

Fig.2- Typical Instantaneous Forward Characteristics

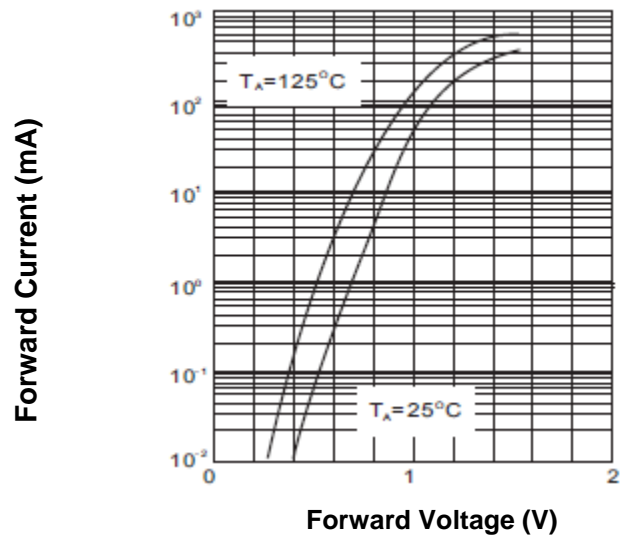

Fig.3- Junction Capacitance Curve

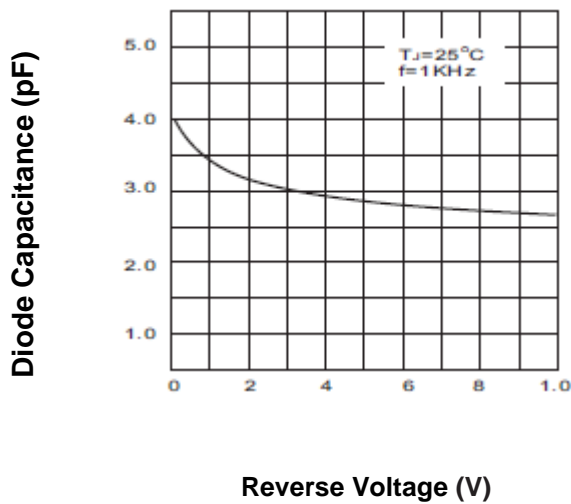

Fig.4- Forward Resistance vs. Forward Current

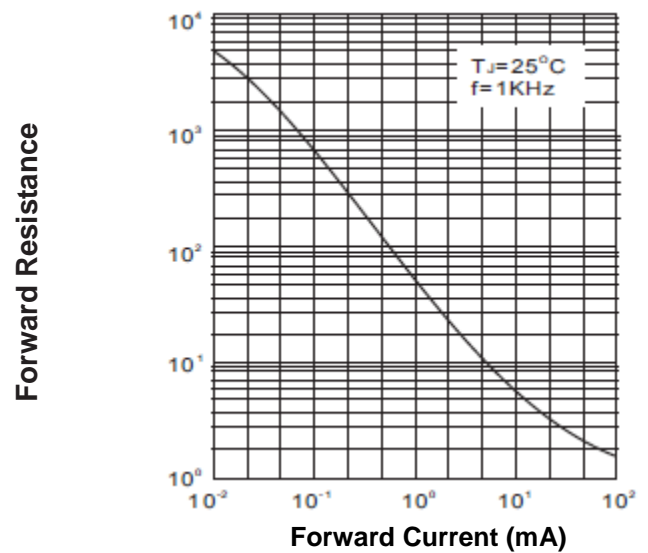
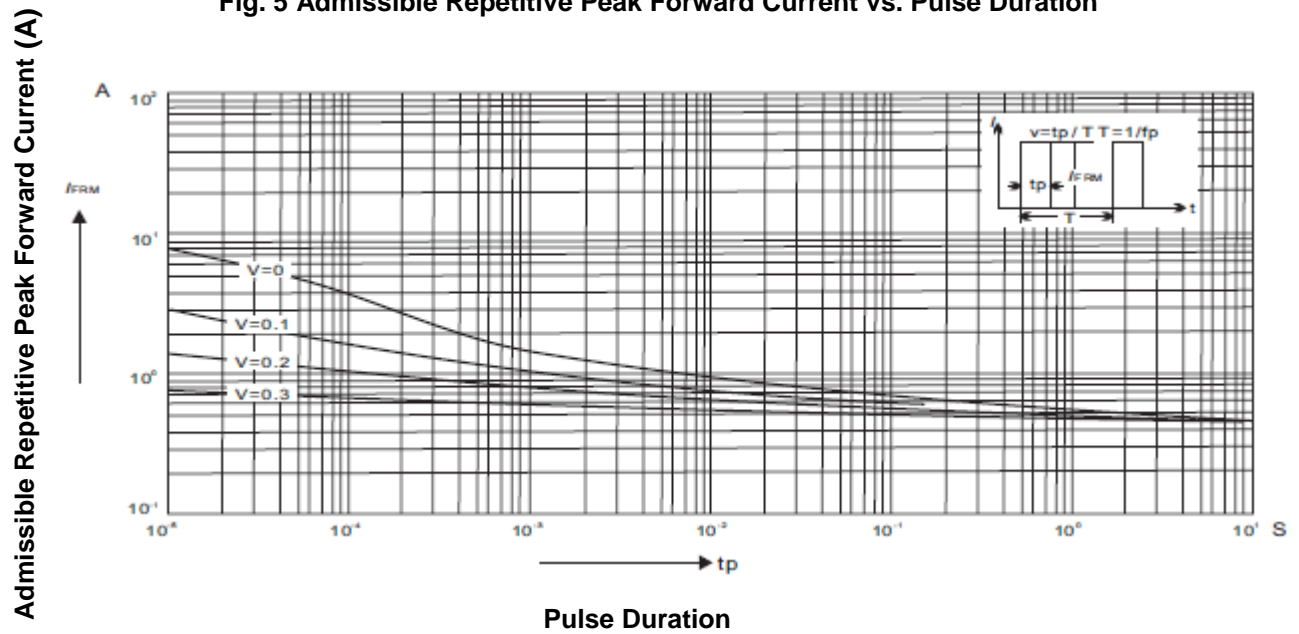
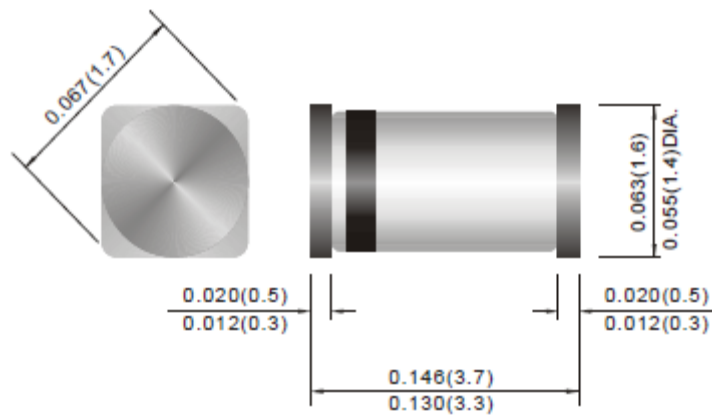

Fig. 5 Admissible Repetitive Peak Forward Current vs. Pulse Duration



Dimensions in inch (mm)



QuadroMELF

Two Terminals Surface Mount Switching Diodes

LS4148

Mount Pad Layout in Inch (mm)

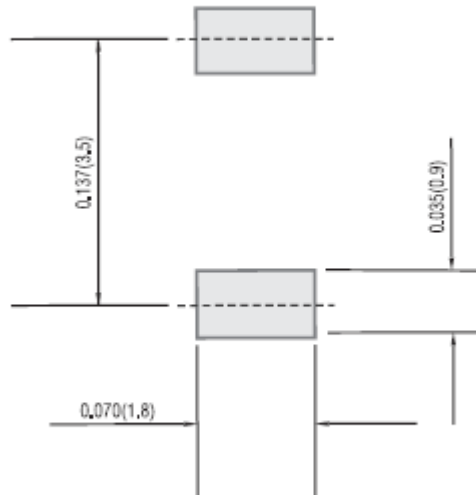

How to Order

LS4148 - XX - XX

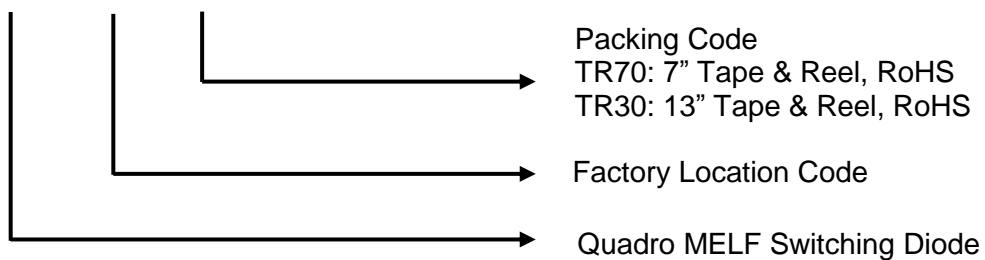

How to contact

US HEADQUARTERS

28040 WEST HARRISON PARKWAY, VALENCIA, CA 91355-4162

Tel: (800) TAITRON (800) 824-8766 (661) 257-6060

Fax: (800) TAITFAX (800) 824-8329 (661) 257-6415

Email: taitron@taitroncomponents.com

Http://www.taitroncomponents.com

TAITRON COMPONENTS MEXICO, S.A .DE C.V.

BOULEVARD CENTRAL 5000 INTERIOR 5 PARQUE INDUSTRIAL ATITALAQUIA, HIDALGO C.P.
42970 MEXICO

Tel: +52-55-5560-1519

Fax: +52-55-5560-2190

TAITRON COMPONENTS INCORPORATED TAIWAN, TAIPEI

5F-2, NO. 77, SEC. 1, HSIN TAI WU ROAD, HSI-CHIH, TAIPEI HSIEN, TAIWAN R.O.C.

Tel: 886-2-2698-8878

Fax: 886-2-2698-8879

TAITRON COMPONETS INCORPORATED, SHANGHAI REPRESENTATIVE OFFICE

METROBANK PLAZA, 1160 WEST YAN'AN ROAD, SUITE 1503, SHANGHAI, 200052, CHINA

Tel: +86-21-5424-9942

Fax: +86-21-5424-9931