

1.0A Surface Mount Sintered Glass Passivated Rectifier (SGP[®])

Features

- Sintered glass passivated (SGP[®]) rectifier chip
- Low profile surface mounted package
- Sintered glass passivated cavity-free junction
- Plastic package has underwriters laboratory flammability classification 94V-0
- High temperature soldering: 260 °C / 10 seconds at terminals
- RoHS compliant



SMA



Mechanical Data

Case:	JEDEC DO-214AC molded plastic
Terminals:	Solder plated solderable per MIL-STD-750, Method 2026
Polarity:	Cathode end indicated by color band
Weight:	0.002 Ounce, 0.064 gram

Maximum Ratings & Electrical Characteristics (*T_{Ambient}*=25°C unless noted)

Symbol	Description	GF 1A	GF 1B	GF 1D	GF 1G	GF 1J	GF 1K	GF 1M	Unit	Conditions
V_{RRM}	Maximum Repetitive Peak Reverse Voltage	50	100	200	400	600	800	1000	V	
V_{RMS}	Maximum RMS Voltage	35	70	140	280	420	560	700	V	
V_{DC}	Maximum DC Blocking Voltage	50	100	200	400	600	800	1000	V	
I_{F(AV)}	Maximum Average Forward Rectified Current	1.0							A	
I_{FSM}	Peak Forward Surge Current	30							A	8.3ms single half sine-wave superimposed on rated load (JEDEC Method)
V_F	Maximum Instantaneous Forward Voltage	1.0							V	I _F =1.0A
I_R	Maximum DC Reverse Current at Rated DC Blocking Voltage	5.0							µA	TA=25° C
		30								TA=125° C
		50								TA=150° C
C_J	Typical Junction Capacitance	12							pF	VR=4V, f=1MHz

1.0 A Surface Mount Sintered Glass Passivated Rectifier (SGP[®])

GF1A - GF1M

Symbol	Description	GF 1A	GF 1B	GF 1D	GF 1G	GF 1J	GF 1K	GF 1M	Unit	Conditions
RthJA	Typical Thermal Resistance	75							°C / W	Note
RthJL		27								
TJ, TSTG	Operating Junction and Storage Temperature Range	-65 to +175							°C	

Note: Thermal resistance from junction to ambient and from junction to lead P.C.B. mounted on 0.2x0.2" (5.0 x5.0mm) copper pad areas.

Typical Characteristics Curves

Fig.1- Forward Current Derating Curve

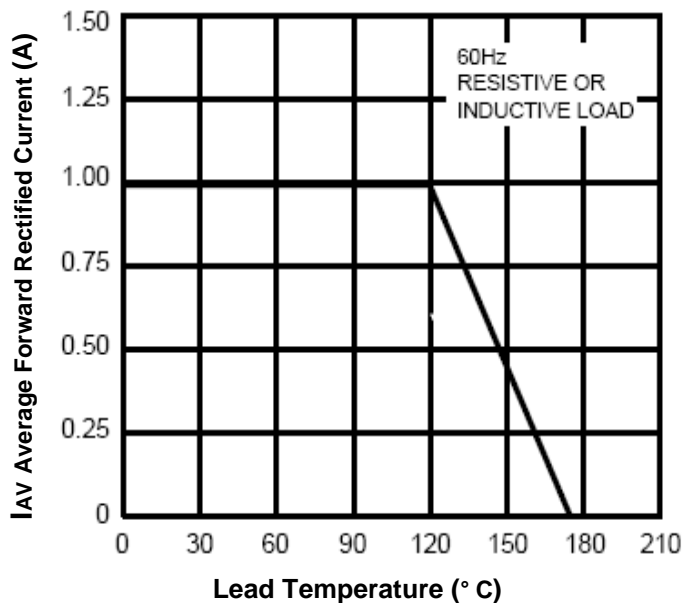
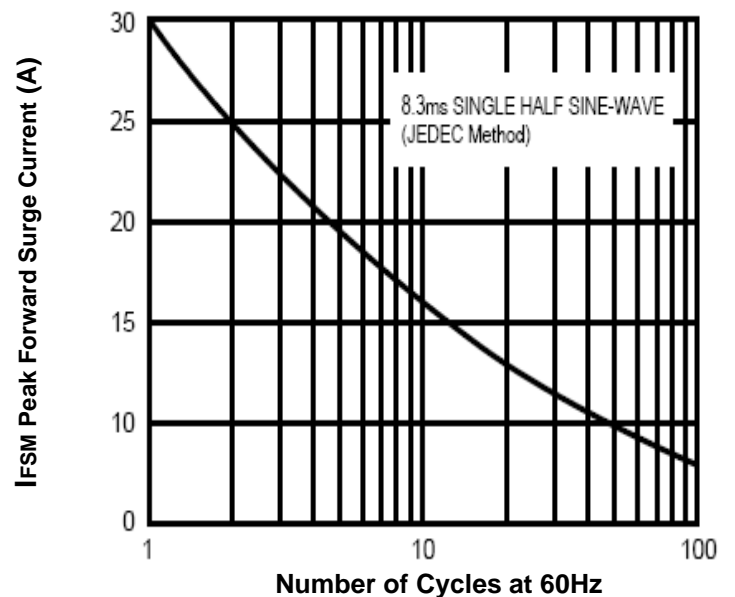

Fig.2- Max. Non-Repetitive Peak Forward Surge Current



1.0 A Surface Mount Sintered Glass Passivated Rectifier (SGP[®])

GF1A - GF1M

Fig.3- Typical Instantaneous Forward Characteristics

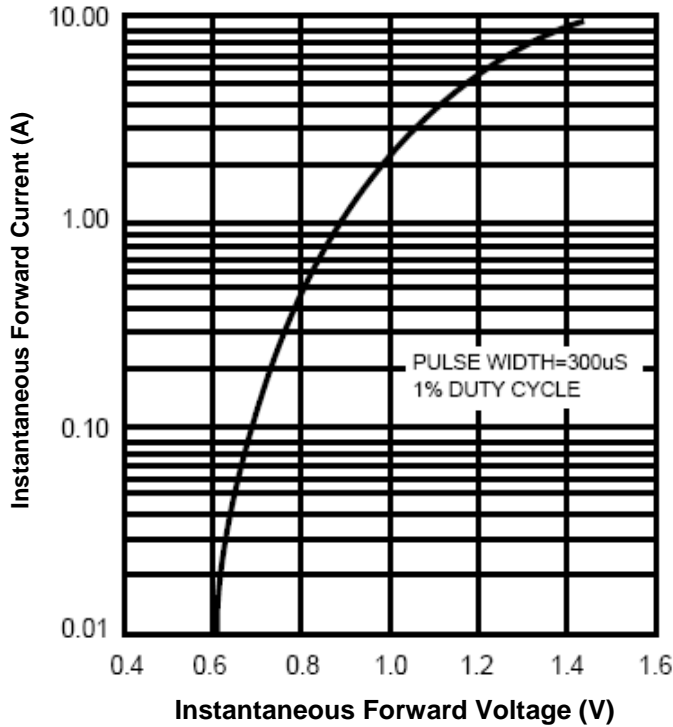

Fig.4- Typical Reverse Characteristics

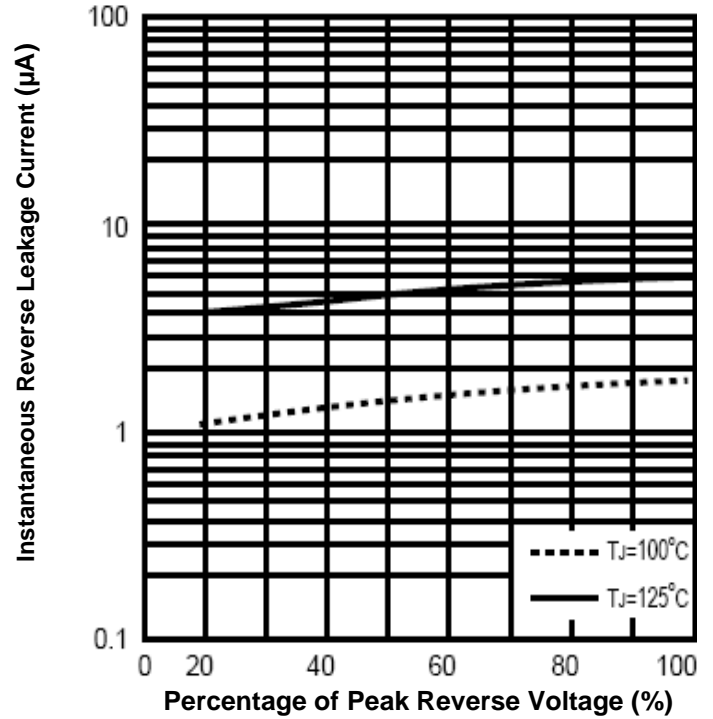
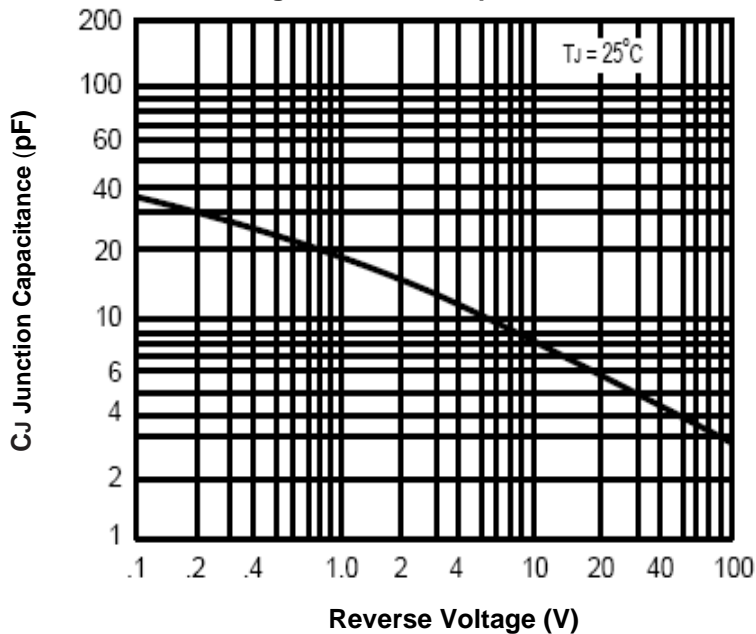

Fig.5- Junction Capacitance



1.0 A Surface Mount Sintered Glass Passivated Rectifier (SGP[®])

GF1A - GF1M

Dimensions in inch (mm)

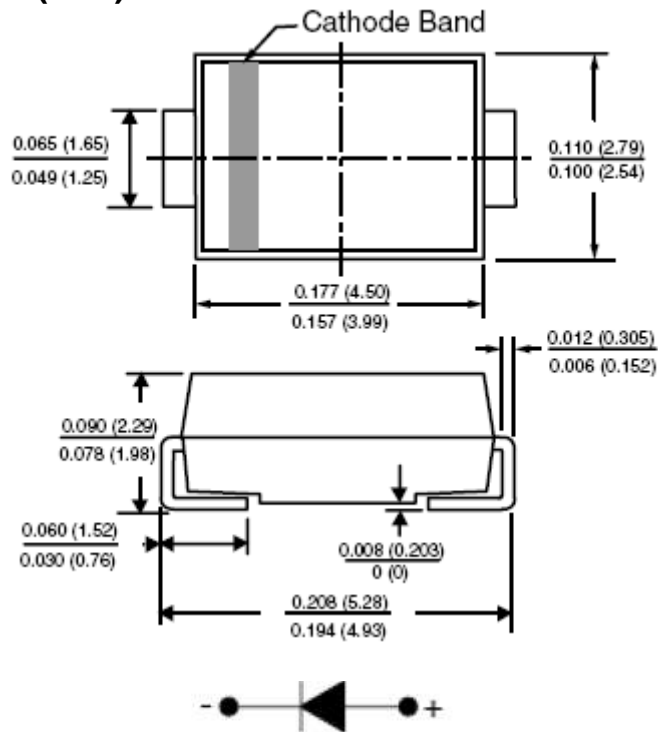

Soldering Pad in inch (mm)

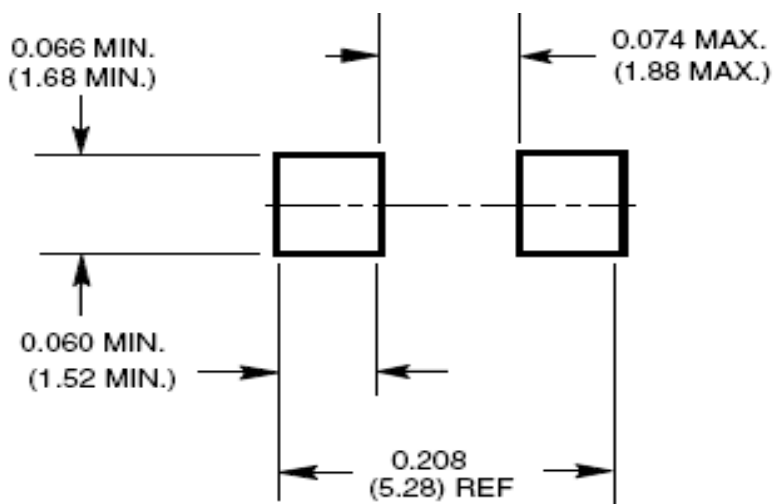

SMA

1.0 A Surface Mount Sintered Glass Passivated Rectifier (SGP[®])

GF1A - GF1M

How to contact us

USA HEADQUARTERS

28040 WEST HARRISON PARKWAY, VALENCIA, CA 91355-4162

Tel: (800)-TAITRON (800)-824-8766 (661)-257-6060

Fax: (800)-TAITFAX (800)-824-8329 (661)-257-6415

Email: taitron@taitroncomponents.com

Http://www.taitroncomponents.com

TAITRON COMPONENTS INCORPORATED TAIWAN BRANCH

6F., NO.190, SEC. 2, ZHONGXING RD., XINDIAN DIST., NEW TAIPEI CITY 23146, TAIWAN R.O.C.

Tel: 886-2-2913-6238

Fax: 886-2-2913-6239

TAITRON COMPONENT TECHNOLOG SHANGHAI CORPORATION

SUITE 1503, METROBANK PLAZA, 1160 WEST YAN'AN ROAD, SHANGHAI, 200052, CHINA

Tel: +86-21-5424-9942

Fax: +86-21-2302-5027