

Multiple Terminals SMD Switching Diode

Features

- Fast Switching Speed
- Surface Mount Package Ideally Suited for Automatic Insertion
- High Conductance
- RoHS compliant

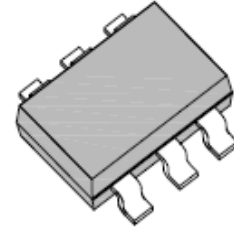

SOT-363

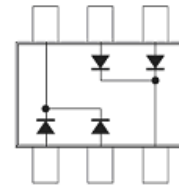

Mechanical Data

Case:	SOT-363, Plastic Case
Terminals:	Solderable per MIL-STD-750, Method 2026
Weight:	Approx. 0.006 gram

Maximum Ratings & Electrical Characteristics ($T_{Ambient}=25^{\circ}C$ unless noted otherwise)

Symbol	Description	BAV70DWS MMBD4148CDWS	Unit	Conditions
	Marking Code	JA		
V_{RM}	Reverse Voltage	75	V	
V_{RRM}	Peak Reverse Voltage	100	V	
I_{F(AV)}	Forward Average Current	150	mA	Half wave rectification with resistive load and $f \geq 50\text{Hz}$
I_{FSM}	Peak Forward Surge Current, Pulse Width=1.0us	4.0	A	
P_D	Power Dissipation Derate above 25°C	200	mW	
V_F	Max. Forward Voltage	0.715	V	IF=1mA
		0.855		IF=10mA
		1.0		IF=50mA
		1.25		IF=150mA
I_R	Max. DC Reverse Current at Rated DC Blocking Voltage $T_j=25^{\circ}C$	0.03	μA	VR=25V
		2.5		VR=75V
C_J	Junction Capacitance	1.5	pF	VR=0V, f=1MHz
T_{rr}	Max. Reverse Recovery Time	4.0	ns	IF=10mA, IR=1mA, VR=6V, RL=100Ω
R_{thJA}	Max. Thermal Resistance	625	° C/W	
T_J	Storage Temperature Range	-55 to +150	° C	

Multiple Terminals SMD Switching Diode

BAV70DWS / MMBD4148CDWS

Typical Characteristics Curves

Fig.1- Forward Power Dissipation Derating Curve

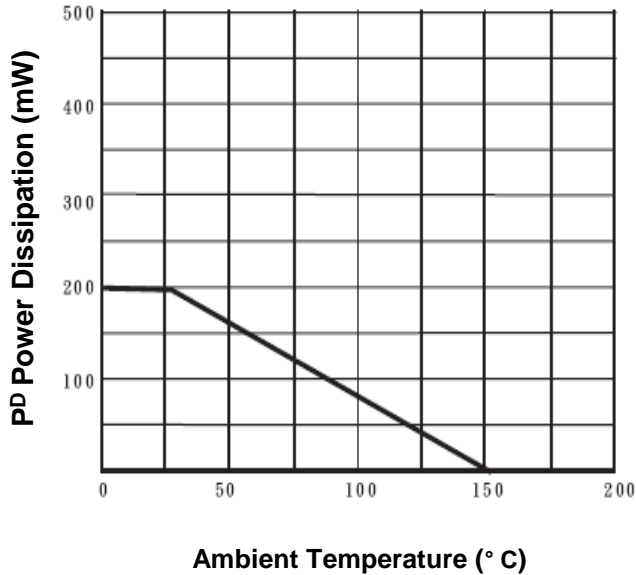

Fig.2- Typical Instantaneous Forward Characteristics

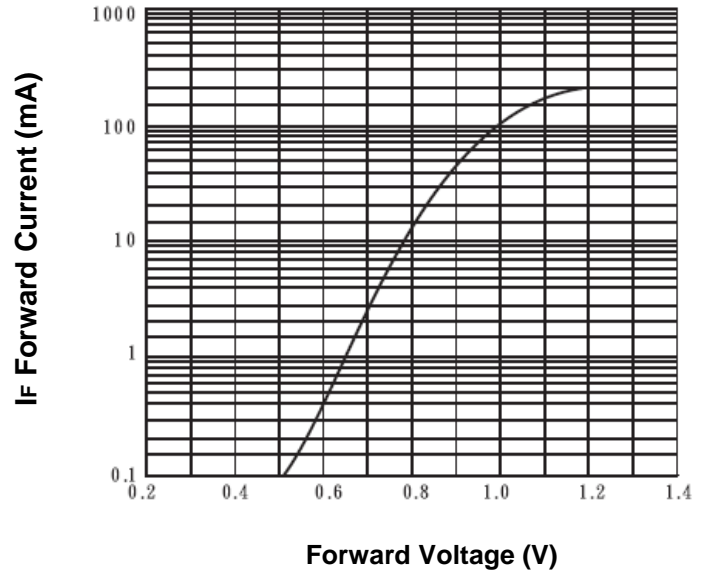
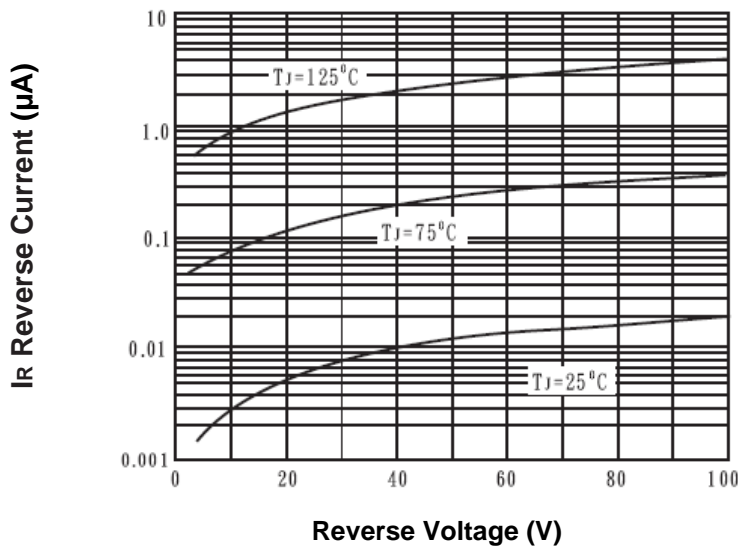

Fig.3- Typical Instantaneous Reverse Characteristics



Multiple Terminals SMD Switching Diode

BAV70DWS / MMBD4148CDWS

Dimensions in inch (mm)

SOT-363

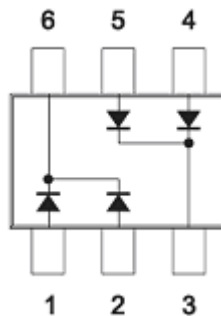
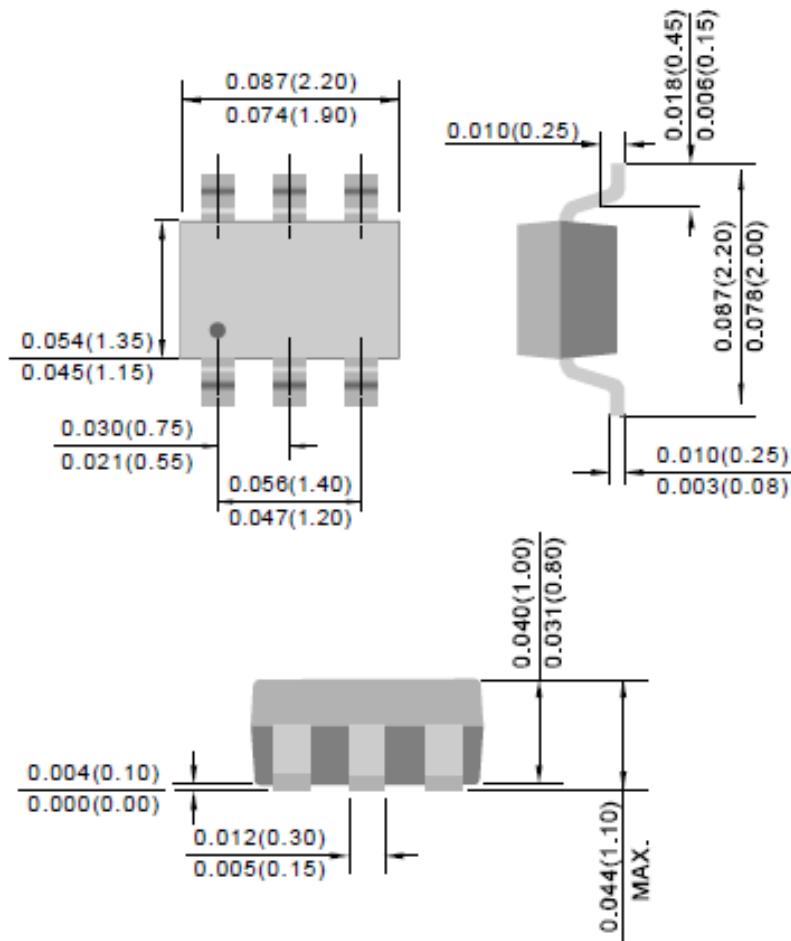

Multiple Terminals SMD Switching Diode

BAV70DWS / MMBD4148CDWS

Mounting Pad Layout in inch (mm)

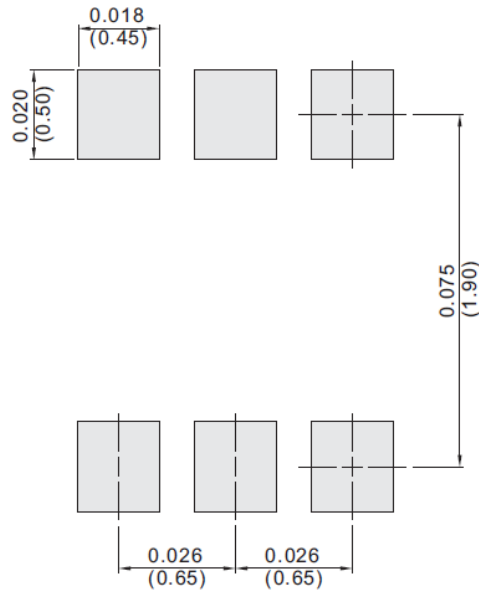

How to contact us

USA HEADQUARTERS

28040 WEST HARRISON PARKWAY, VALENCIA, CA 91355-4162

Tel: (800)-TAITRON (800)-824-8766 (661)-257-6060

Fax: (800)-TAITFAX (800)-824-8329 (661)-257-6415

Email: taitron@taitroncomponents.com

Http://www.taitroncomponents.com

TAITRON COMPONENTS INCORPORATED TAIWAN BRANCH

6F., NO.190, SEC. 2, ZHONGXING RD., XINDIAN DIST., NEW TAIPEI CITY 23146, TAIWAN R.O.C.

Tel: 886-2-2913-6238

Fax: 886-2-2913-6239

TAITRON COMPONENT TECHNOLOG SHANGHAI CORPORATION

SUITE 1503, METROBANK PLAZA, 1160 WEST YAN'AN ROAD, SHANGHAI, 200052, CHINA

Tel: +86-21-5424-9942

Fax: +86-21-2302-5027