

Three Terminals SMD Switching Diodes

Features

- Fast switching speed
- Surface mount package ideally suited for automatic insertion
- Electrically Identical to Standard JEDEC
- High conductance
- RoHS compliant

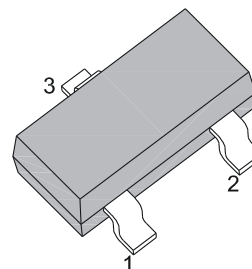

SOT-23

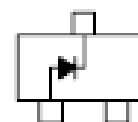

Mechanical Data

Case:	SOT-23, Plastic Case
Terminals:	Solderable per MIL-STD-202G, Method 208
Weight:	Approx. 0.008 gram

Maximum Ratings ($T_{Ambient}=25^{\circ}C$ unless noted otherwise)

Symbol	Description	BAS19	BAS20	BAS21	Unit	Conditions
	Marking Code	A8	A80	A82		
V_R	Reverse Voltage	100	150	200	V	
V_{RRM}	Peak Reverse Voltage	120	200	250	V	
I_{F(AV)}	Average Forward Rectified Current	0.2			A	Half Wave Rectification with Resistive Load and $f \geq 50\text{Hz}$
I_{FSM}	Peak Forward Surge Current	2.5			A	$t = 1.0\mu\text{s}$
P_D	Power Dissipation	250			mW	Derate above 25° C
R_{thJA}	Thermal Resistance from Junction to Ambient Air	500			° C/W	
T_J, T_{STG}	Operating Junction and Storage Temperature Range	-55 to +150			° C	

Three Terminals SMD Switching

BAS19/BAS20/BAS21

Electrical Characteristics ($T_{Ambient}=25^{\circ}\text{C}$ unless noted otherwise)

Symbol	Description	BAS19	BAS20	BAS21	Unit	Conditions
V_F	Forward Voltage		1.0		V	$I_F=0.1\text{A}$
I_R	DC Reverse Current at Rated DC Blocking Voltage		0.1		μA	$T_J=25^{\circ}\text{C}$
C_T	Total Capacitance		5.0		pF	$V_R=0\text{V}$, $f=1.0\text{MHz}$
T_{rr}	Reverse Recovery Time		50		nS	From $I_F=10\text{mA}$ to $I_R=1\text{mA}$, $V_R=6\text{V}$, $R_L=100\Omega$

Typical Characteristics Curves

Fig.1- Power Derating Curve

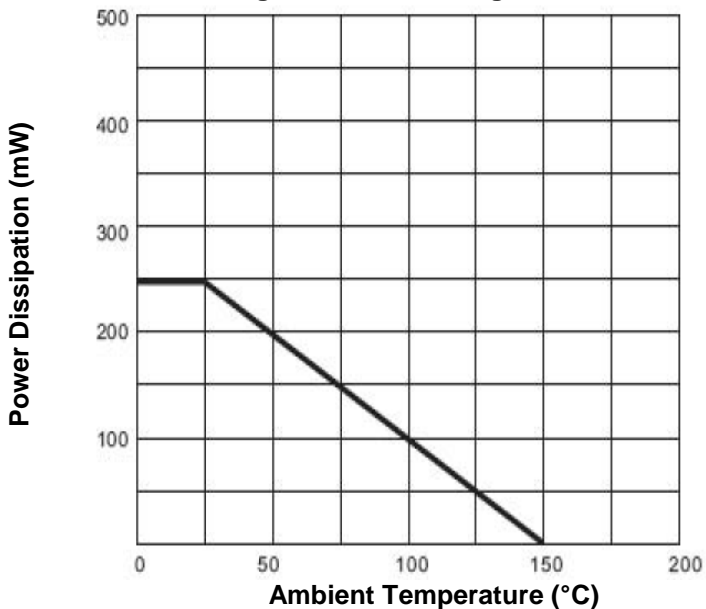
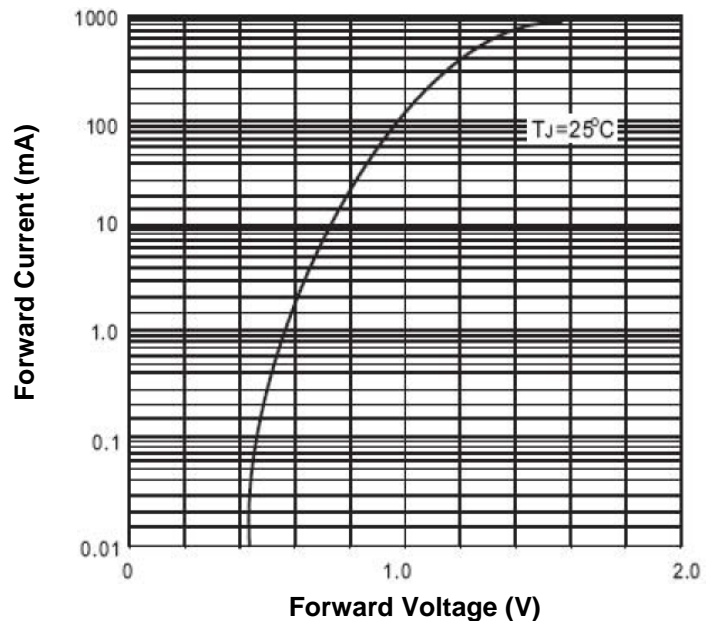

Fig.2- Typical Forward Characteristics



BAS19/BAS20/BAS21

Fig.3-Leakage Current vs. Junction Temperature

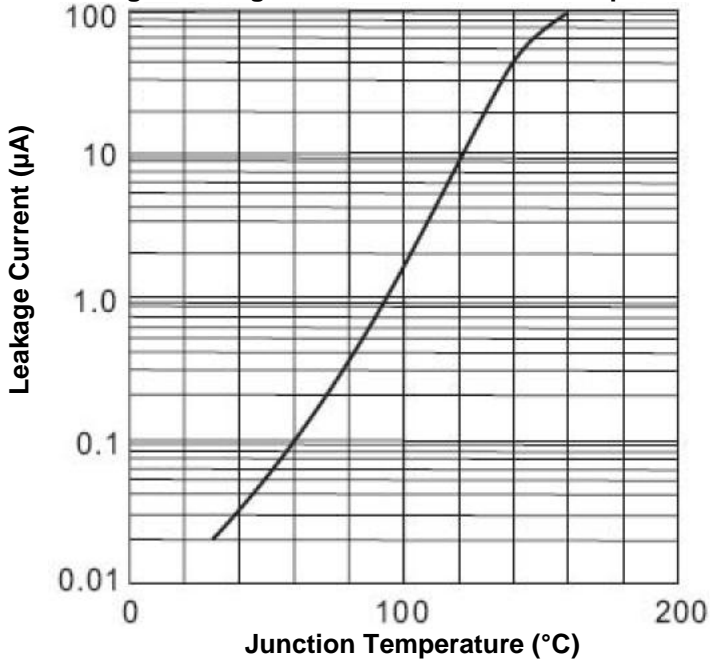
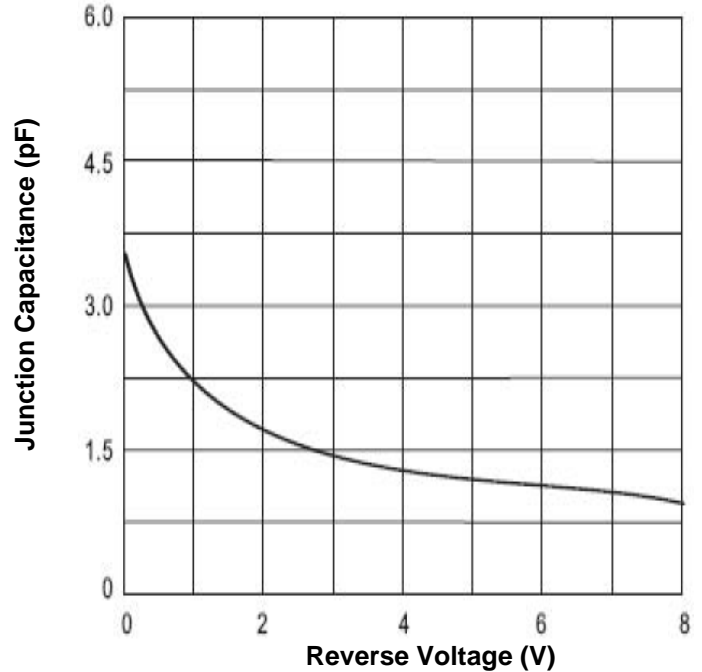
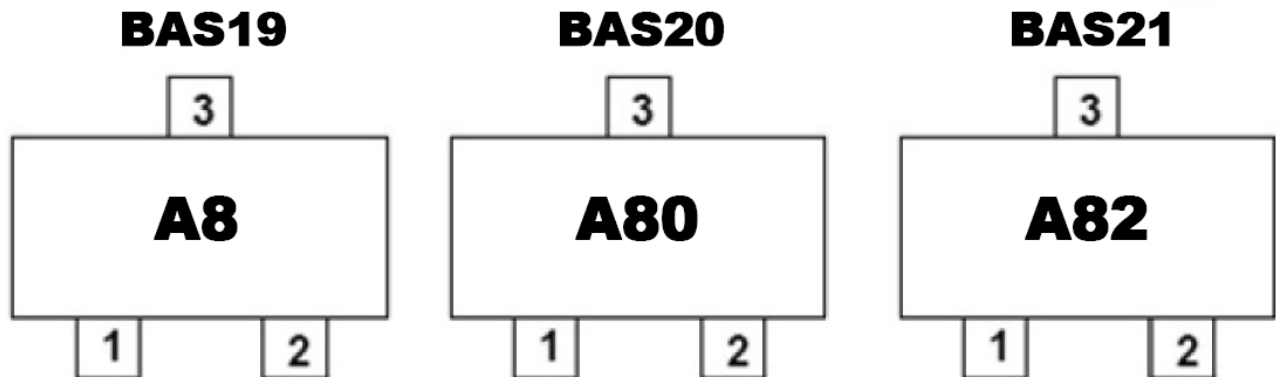

Fig.4- Typical Junction Capacitance



Marking Information:



Dimensions in mm (inch)

SOT-23

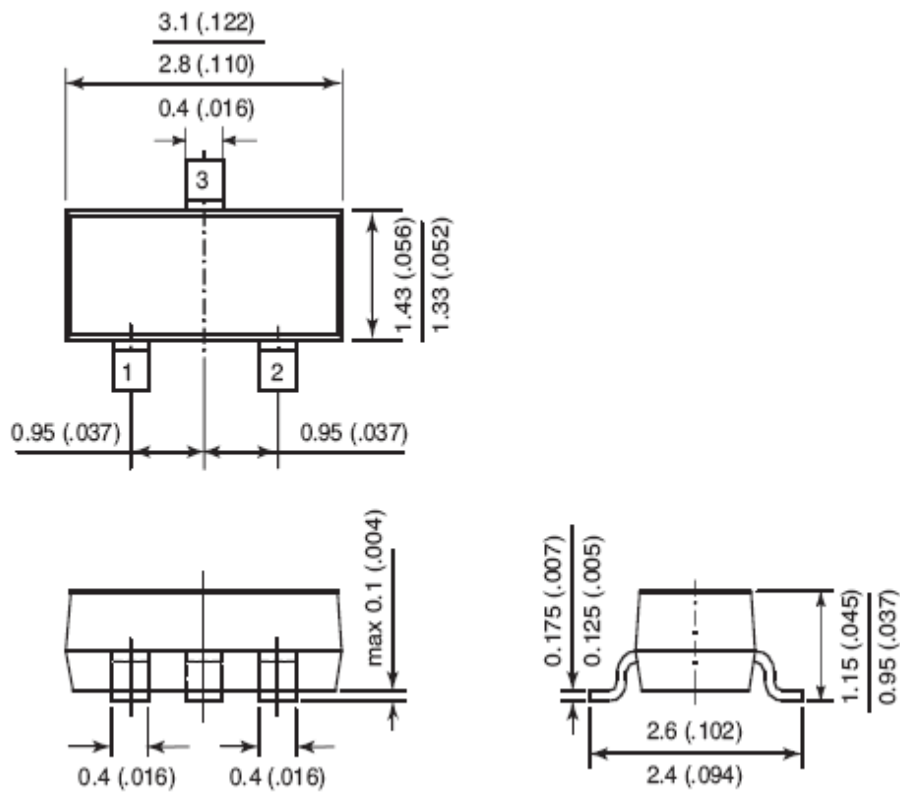

Mounting Pad Layout in mm (inch)

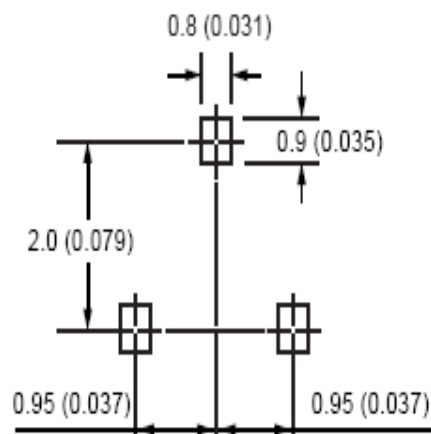

Packing Information:

Carrier Tape Dimensions (in mm)

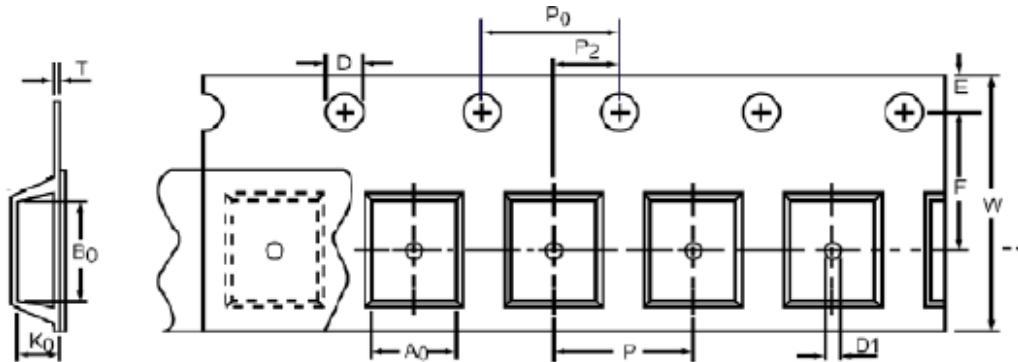

Product Type	A0	B0	K0	D	P0	P
	See Note				1.55±0.5	4.0±0.1
SOT-23	W	E	T	D1	F	P2
	8.0+0.3/-0.1	1.75±0.1	0.38±0.1	1.0±0.05	3.5±0.5	2.0±0.05

Note: Symbol A0, B0, K0 are determined by the maximum dimensions of the component size.
The clearance between the component and the cavity must be within 0.05 mm (0.002") min. to 0.50 mm (0.02") max. for 8 mm tape.

Reel Dimensions (in mm)

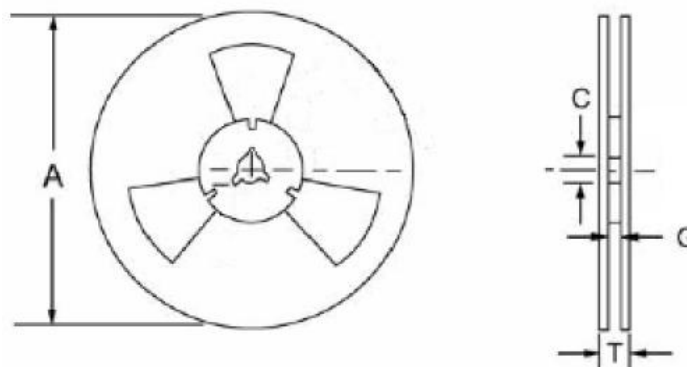

A	C	G	T
178.0±2.0	13.0±0.5	8.4±2.0	14.4 max.

Packing Quantity Information:

Quantity	PCS per Inner Box	PCS per Inner Carton
TR70 Tape & Reel	3000/Reel	240000

Inner Carton Size Information:

Cartoon Size
390X270X400 (in mm)

How to contact us

USA HEADQUARTERS

28040 WEST HARRISON PARKWAY, VALENCIA, CA 91355-4162

Tel: (800)-TAITRON (800)-824-8766 (661)-257-6060

Fax: (800)-TAITFAX (800)-824-8329 (661)-257-6415

Email: taitron@taitroncomponents.com

Http://www.taitroncomponents.com

TAITRON COMPONENTS INCORPORATED TAIWAN BRANCH

6F., NO.190, SEC. 2, ZHONGXING RD., XINDIAN DIST., NEW TAIPEI CITY 23146, TAIWAN R.O.C.

Tel: 886-2-2913-6238

Fax: 886-2-2913-6239

TAITRON COMPONENT TECHNOLOG SHANGHAI CORPORATION

SUITE 1503, METROBANK PLAZA, 1160 WEST YAN'AN ROAD, SHANGHAI, 200052, CHINA

Tel: +86-21-5424-9942

Fax: +86-21-2302-5027